



TECHNICAL GUIDE
2ND EDITION
(Revised 01/02/2025)

CONTENTS

3 WALLS

4	GENERAL INFORMATION
9	GRAND LEDGE™
13	OUTCROPPING
21	KODAH®
24	BELVEDERE®
29	HEARTWOOD
31	DIMENSIONAL

33 SLABS & PAVERS

34	GENERAL INFORMATION
37	GAUGE SELECT
40	MID-CENTURY
43	MONTROSE
45	ARCADIA
48	TETRA
50	GRAND FLAGSTONE
54	DIMENSIONAL FLAGSTONE
57	NEW MISSION
60	SUPERIOR STEPPERS

61 STEPS

62	GENERAL INFORMATION
63	EMPIRE
64	DIMENSIONAL
65	IRREGULAR

66 FIRE FEATURES

67	GENERAL INFORMATION
68	BELVEDERE® FIRE PIT
70	KODAH® FIRE PIT
71	DIMENSIONAL FIRE PIT

72 COPING & CAPS

73	DIMENSIONAL COPING
74	CAMDEN COPING
75	BELVEDERE® COPING
76	DIMENSIONAL CAPS
77	CAMDEN CAPS

78 WARRANTY

Written specifications and preliminary wall height guides for products are available on our website.

MATERIALS

WETCAST

HIGH FORMAT® products are primarily made of concrete utilizing our wetcast production system. Wetcast concrete offers benefits including:

- Detailed, natural looking textures
- Seamless blending of colors throughout
- Long-term structural integrity

WETCAST WITH VIBRALOCK®

VIBRALOCK® is an integrated surface technology that is directly incorporated into the production process of many of our slab and paver products to deliver benefits including:

- A harder surface with greater resistance to abrasion
- More vibrant and enduring color
- Increased resistance to efflorescence

TEKTRAMAT®

TEKTRAMAT® is our proprietary material based around ultra high performance concrete technology (UHPC). Products made from this material offer benefits including:

- Unsurpassed durability including salt proof surface
- Ultra-realistic replication of fine detail
- Efficient installation resulting from large yet thinly formatted shapes

Technical information for our natural stone products can be found on our website.

For your convenience, please scan our QR code to download our marble and travertine French pattern paver layout sheet.



WALLS

GENERAL INFORMATION

GRAND LEDGE™

OUTCROPPING

KODAH®

BELVEDERE®

HEARTWOOD

DIMENSIONAL

PRE-CONSTRUCTION CHECKLIST

Before you start construction, take the time to complete the necessary planning and preparation. This process will keep your project running efficiently and will aid in completing a quality installation.

Make sure to address the following:

SAFETY

Your safety program should address items such as personal protective equipment, maintaining safe slopes and excavations, fall protection, rigging and lifting, as well as any other relevant safety precautions.

ENGINEERING AND PERMITS

Obtain the necessary engineering design and permits for your project. The soils for foundation and wall backfill should be properly evaluated by a trained professional. Unsuitable soils should be removed and replaced as recommended.

Note: This installation guide is intended to supplement a detailed, site-specific wall design prepared by a Professional Engineer. The construction documents for your project supersedes any recommendations presented here.

REVIEW THE PROJECT PLANS

Take the time to review and understand the project plans and specifications. Make sure you understand the detailed design for the project before starting construction. A pre-construction meeting with the wall designer, construction inspector, wall contractor, and owner or representative is recommended. Don't be afraid to ask questions.

CONSTRUCTION PLANNING

Develop a plan to coordinate construction activities (material delivery/storage, equipment access, etc.) on your site. Make sure your plan specifically addresses how to control surface water during construction.

UTILITY LOCATION

Make sure to have underground utilities located and marked on the ground before starting any construction.

Call 8-1-1 or go online to call811.com to schedule utility marking for your project site.

MATERIAL STAGING

Store retaining wall blocks in a location close to the proposed wall. Blocks should be kept clean and mud free. Blocks should also be stored in a location which will minimize the amount of handling on the project site.

Store geogrid in a clean, dry location close to the proposed wall site. Keep the geogrid covered or in the shade until installation to avoid exposure to direct sunlight.

EQUIPMENT

Make sure you have the proper equipment to handle retaining wall blocks and pallets on the construction site. (Note: A specially designed Lifting Device is required for the installation of Outcropping and Grand Ledge™ blocks).

Hand operated equipment used in wall construction should include shovels, rake, 2 ft (600 mm) level, 4 ft (1.2 m) level, broom, hammer, chisel, tape measure, string, spray paint, laser level, pry bar, concrete saw and a walk behind vibratory plate compactor capable of delivering a minimum of 2000 lb (9 kN) centrifugal force.

Personal protective equipment should include appropriate clothing, steel toe boots, eye protection, respiratory protection, hard hat, gloves, hearing protection, fall protection, rigging, and other items as necessary to insure a safe working environment.

Note: On small or difficult to access sites, it is helpful to have two lifting devices. One for moving material from pallets to the site and another for setting blocks. This will allow for the material staging area to be located away from the construction space while providing safe and efficient access to the material in less than desirable site conditions.



Outcropping / Grand Ledge™ lifting device required for proper installation.

INSTALLATION GUIDE

BASIC RETAINING WALL INSTALLATION NOTES FOR:

- Outcropping
- Grand Ledge™
- Belvedere®
- Kodah®
- Heartwood
- Dimensional

Refer to product pages for specific information and details pertaining to individual products.

FOR THE MOST NATURAL APPEARANCE, MIX AND INSTALL PRODUCTS FROM MULTIPLE PALLETS SIMULTANEOUSLY. THIS WILL CREATE A MORE BLENDED, NATURAL LOOK.

BASE PREPARATION

Proper base preparation is a critical element in the construction of your retaining wall. Not only is it important to provide a stable foundation for the wall, but a properly prepared base will greatly increase the speed and efficiency of your wall installation.

Proper base preparation starts with the subgrade soils (soils below the leveling pad). A typical wall requires excavation of at least 12 in (300 mm). This will provide 6 in (150 mm) for the leveling pad and 6 in (150 mm) of minimum bury of the blocks.

Note: excavation and bury depth will vary by product type and design. Please see project plans or product specific information for further information. Subgrade soils should be firm and capable of supporting the loads from the wall. At a minimum, all topsoil, organic, and other unsuitable soils should be removed from below the wall. The minimum width of the leveling pad should be 18 in (465 mm) wider than the width of the block. This will provide 6 in (150 mm) in front of and 12 in (300 mm) behind the bottom block. **Note: For Outcropping and Grand Ledge™ installation, you will need a wider leveling pad to ensure there is enough space for the depth of the blocks. The back cut behind the wall should taper and provide at least 18 in (465 mm) of space to ensure that the lifting device has enough clearance to be removed efficiently. When the back cut is too close to the back side of the wall, the device can get wedged and be hard to remove.**

Once excavated, the subgrade soil should be compacted to a minimum of 95% maximum density as determined by a standard proctor test (ASTM D698). At this point the soil should be firm and free of topsoil, debris, roots, etc. Consult a soils engineer if in doubt. Any unsuitable material shall be excavated and replaced with compacted granular soils as directed by the engineer.

LEVELING PAD

Base preparation continues with proper leveling pad construction. An open-graded (free-draining) crushed stone leveling pad is typically used for retaining walls. Walls can also be designed with a dense-graded crushed stone or concrete leveling

pad. The choice of which type of leveling pad to use is made by the wall designer and depends on several factors including the bearing capacity of the native soil, location of the drain outlet, conditions at the base of the wall, and any other special considerations for the wall.

The leveling pad material should be placed and compacted to provide a uniform, level foundation on which to construct the retaining wall. Proper elevation can be established with a laser level or transit. Check for level both parallel and perpendicular to the wall.

Place and compact leveling pad material as specified in the wall design. If crushed stone is used, place the stone in uniform loose lifts a maximum of 6 in (150 mm) thick. Lift sizes are relative to the size of the compactor being used. Compact the stone with a minimum of three passes with a 24 in (610 mm) wide, walk-behind, vibrating plate compactor

Note: Do NOT place a thin layer of sand between the leveling pad and bottom block. This layer will reduce the sliding resistance between the leveling pad and bottom block, as well as reduce the drainage capacity of the foundation stone.

DRAIN

A drain is installed in the lowest part of the open graded (free-draining) stone behind the retaining wall. If an open graded crushed stone leveling pad is used, the drain is installed on the bottom of the crushed stone leveling pad. If a dense graded crushed stone leveling pad is used, the drain is installed immediately on top of the dense graded stone.

Typically, a 4 in (100 mm) diameter perforated or slotted pipe (PVC or corrugated HDPE) is used. Daylight the drain pipe at the ends and/or through the face of the wall every 50 ft (15 m) to allow for drainage. The pipe can also outlet into a nearby drainage ditch or catch basin. Because water can flow both ways through the drain pipe, connection to a catch basin or active storm sewer should only be made under the direction of a Professional Engineer.

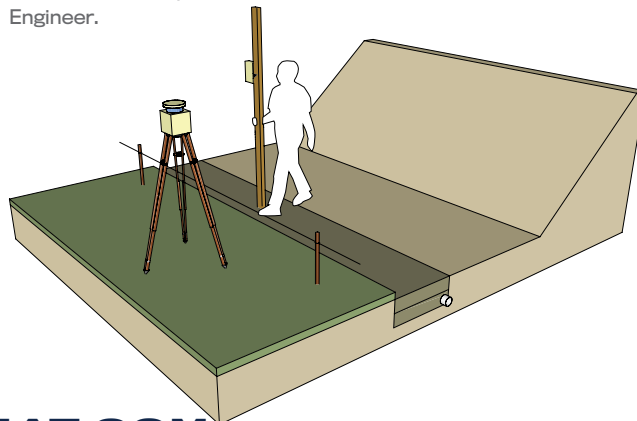
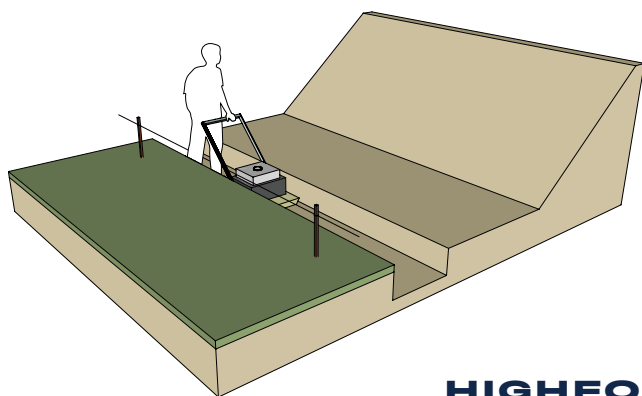

GENERAL INFORMATION

SETTING THE BOTTOM COURSE OF BLOCKS

Proper placement of the bottom course of wall stones is critical in determining the overall appearance and integrity of the finished project. Take extra time on this step and the rest of the project will go smoothly. At this point you need to determine the best point of origin for the wall. If you have a fixed point, such as a building corner or a 90° corner, you will want to start the wall from that point and work your way out. This will minimize cutting of blocks. If there are no fixed points, start the wall at the lowest design elevation, as it is easier to step the base up than it is to step the base down.

Properly mark the location of the retaining wall. A string line or offset stakes are typically used to establish horizontal and vertical alignment. Review the Outcropping section for specific instructions on block alignment.

Where applicable, remove the bottom lip from the back edge of the blocks (applicable for Outcropping and Grand Ledge) with a hammer and chisel (bottom course of blocks only) so the blocks will lie flat on the leveling pad.

Place a complete row of blocks on the prepared leveling pad. Blocks should be placed tight together.

Check all blocks for level from front to back and side to side as they are placed. Place and compact backfill in front of the bottom row of blocks to help hold them in place. Compaction should be to 95% maximum density as determined by a standard proctor test (ASTM D698).

Place open-graded crushed stone in the wedge-shaped gap between the blocks and at least 12 in (300 mm) behind the wall. A stone meeting the gradation requirements of ASTM No. 57 with no material passing the No. 200 sieve is preferred. Place the stone in uniform loose lifts a maximum of 8 in (200 mm) thick. Fully consolidate the stone. Carefully hand tamp the stone within 12 in (300 mm) of the blocks.

Place non-woven geotextile fabric between the drainstone and the remaining backfill material if specified. This prevents backfill material from migrating into, and clogging, the open-graded drainstone.

Backfill behind the drainstone with material as specified in the project design. Place the material in loose lifts as specified, but not to exceed 8 in (200 mm) maximum. Granular backfill shall be compacted to a minimum of 95% maximum density as determined by a standard proctor test (ASTM D698). Do not use any organic, topsoil, frozen, soft, wet, or loose soils when backfilling the wall.

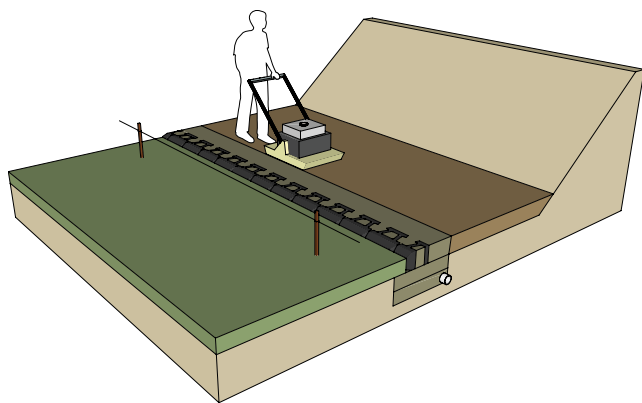

Re-check all units for level and alignment and sweep the top of each course of blocks clean before starting construction of the next course.

SETTING THE UPPER COURSES OF BLOCKS

Placing the next course of blocks is similar to placing the first course. Blocks should be placed to establish a running bond pattern (Dimensional collections) or to follow an irregular pattern (Outcropping, Grand Ledge™, Kodah®, Belvedere® and Heartwood collections).

Blocks should be installed with their sides pushed tight. Push blocks from Outcropping and Grand Ledge™ collections forward until the lip on the back of the block comes in full contact with the blocks below. Make sure that no stones get caught or wedged between the lip and the back of the blocks below. Walls without the lip on the bottom (Belvedere®, Dimensional, Kodah® and Heartwood collections) should not be stacked exactly vertical. Instead, they should be setback as specified by each product line.

(Outcropping: Place a layer of non-woven geotextile fabric directly behind the blocks. This will keep materials from eroding through the small voids between the blocks.)

Place geogrid reinforcing behind the wall as specified in the project documents. See geogrid installation information in the next section for further details.

Place and compact open-graded crushed stone between the blocks, and at least 12 in (300 mm) behind the wall following the procedure used for the bottom course of blocks.

Place non-woven geotextile fabric between the drainstone and the remaining backfill material if specified.

Place and compact backfill behind the drainstone following the procedure used for the bottom course of blocks.

Re-check all units for level and alignment and sweep the top of each course of blocks clean before starting construction of the next course.

Repeat these steps with each course of blocks to the top of the wall.

FOR ALL INSTALLATIONS

Never stack blocks more than one course above grade of backfill.



GENERAL INFORMATION

GEOGRID INSTALLATION

Stability of reinforced soil walls rely on the interaction between geogrid reinforcement, soil in the reinforced zone, and the retaining wall blocks. It is very important that reinforced soil walls be constructed per the detailed design prepared by a Professional Engineer. Make sure you are using the proper type and strength of geogrid listed in the design. The geogrid layers need to be placed at the proper elevations and to the proper distances into the reinforced soil zone detailed in the design. It is also critical to use the appropriate backfill soil material in the reinforced soil zone.

Construct the wall up to the elevation of the geogrid layer shown in the design.

Place geogrid layers as shown in the project details extending into the reinforced soil zone to the design length.

Geogrid must be installed with the strong direction (roll direction) into the reinforced soil zone and not parallel to the wall. Geogrid must be placed in a continuous sheet throughout its length from the connection at the blocks to the back of the reinforced zone. Do not splice or overlap the geogrid.

For all retaining wall products except the Outcropping collection, use the next layer of blocks to secure the front end of the geogrid (creating a friction connection). Make sure the geogrid is as close as possible to the front face of the wall without being visible. Pull the geogrid taut to eliminate any folds and to pretension the geogrid. Pin or secure the back edge of the geogrid before placing the reinforced fill. Review the Outcropping section for specific instructions on geogrid and parawab strap installation.

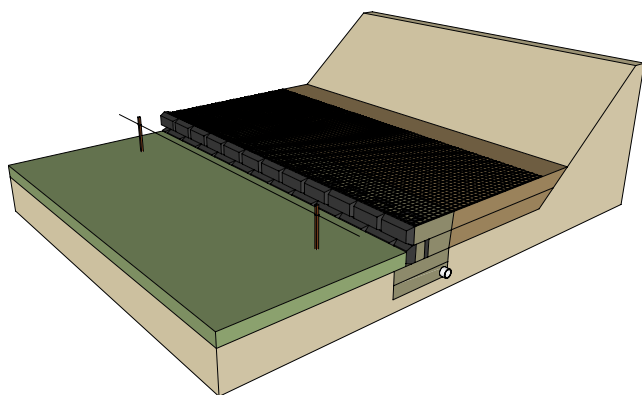

FINISHING THE TOP OF THE WALL

Completing a few simple tasks near the end of the project will ensure that the wall will function properly and look good for years to come.

Grade the top of the wall in such a way that surface water runs off away from the wall. Never leave the top of a wall graded where surface water will pond behind the wall, or saturate the backfill soils.

Place a layer of non-woven geotextile fabric over the top of the drainstone at the back of the wall. This will keep topsoil from migrating into the drainstone and causing problems.

If required, place the coping layer on the top of the wall. The coping blocks should be placed towards the front edge of the wall blocks and should sit securely on top without tipping forward

under their own weight. The coping layer should be carefully adhered with a concrete adhesive specifically formulated for segmental concrete block wall construction.

Note: With **Outcropping and Grand Ledge™**, freestanding units can be used as capstones for applications where the top of wall is expected to be above the finished grade behind the wall. If the freestanding units are not available in your local market, **HIGH FORMAT®** step units are also a great option.

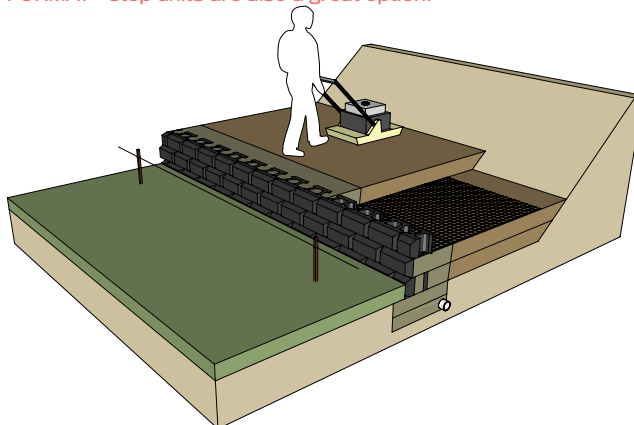

MORE INFORMATION

Refer to product-specific **Notes and Typical Construction Details** for specific applications and construction practices such as corner construction, drain placement, curve construction, and other details.

Typical allowable construction tolerance at the wall face is 1 in (25 mm) in 10 ft (3 m) (1:120) in the vertical and horizontal directions, and a rotation tolerance of 2° from wall batter.

Once you commence working, continue without interruption or delays. This will help expedite construction and minimize the time the excavation is open.

If at any time ground water seepage is observed along the exposed excavation behind the retaining wall, contact the wall designer immediately to determine the corrective action needed.

The construction site should be graded and maintained to direct surface water runoff away from the retaining wall throughout the entire construction process. If there is a rain event with surface water runoff producing erosion or scour near the retaining wall, contact the wall designer immediately to determine the corrective action needed.

WATER APPLICATIONS

Due to the nature of wetcast concrete, the HIGH FORMAT® wall systems are well-suited for many shoreline and water applications. From small water features to custom ponds or where shoreline protection is needed, the wall systems can be implemented to provide the erosion control needed without sacrificing the natural aesthetic of your project.

Refer to the typical design details for more information. Once you've gathered the necessary details of the project, site conditions, and any local building requirements, reach out to your local HIGH FORMAT® representative for further details.

ADDITIONAL INSTALLATION NOTES FOR:

- **Outcropping**

Refer to product pages for specific information and details pertaining to individual products.

INSTALLATIONS REQUIRING GEOGRID

Please visit highformat.com for detailed cross-sections of geogrid reinforced Outcropping walls. For Outcropping installations, do not overlap geogrid over top of blocks. Instead, run the geogrid directly up to the back of the blocks. In addition to this reinforcement, a Paraweb strap must be installed through each lifting hook in the back of the Outcropping blocks. Please see standard details for Reinforced Outcropping Walls for further information.

Place and compact drainstone and reinforced fill following the procedure used to set the bottom and upper courses of blocks. It is important to place and compact stone and reinforced fill starting at the back of the retaining blocks and extending into the reinforced soil zone. This will help eliminate bunching of the geogrid reinforcement.

Reinforced zone fill material is typically a sand or gravel with less than 5% fines in (material passing the No. 200 sieve). This material is usually classified as a GW, GP, SW, or SP. It is very important that you only use the fill material specified in your project design drawings and specifications.

Place retained soil immediately between the reinforced soil zone and the back of the excavation. Material should be placed in loose lifts of 6 in (150 mm) maximum and compacted to 95% maximum density as determined by a standard proctor test (ASTM D698). Bring the reinforced and retained soil up to grade at the same time. At no time should the elevation of the reinforced soil be more than 1 block higher than the retained soil.

Tracked construction equipment should not be used directly on the geogrid. A minimum of 6 in (150 mm) of fill is required between tracked equipment and geogrid to prevent damage to the grid. Rubber-tired equipment may pass over the geogrid when traveling at low speeds of 5 mph (8 km/h) or less.

Avoid any sudden stopping or turning of construction equipment in the reinforced fill zone to prevent moving or damaging the geogrid layers.

Follow geogrid manufacturer's requirements, including requirements for vertical separation and overlap of geogrid.

OUTCROPPING OFFSETS BY HEIGHT OF BLOCK

One of the unique features of the Outcropping system is multiple block heights. To provide a uniform wall batter with multiple height blocks, the setback of the blocks varies proportionally with the block height. The setback in blocks is achieved with shear heels which are cast into the blocks. For a 6 in (152 mm) high block, the shear heels are 1.5 in (38 mm) deep (1/2 times 3 in (76 mm)). For a 12 in (305 mm) high block, the shear heels are 3 in (76 mm) deep (1 times 3 in (76 mm)). For an 18 in (457 mm) high block, the shear heels are 4.5 in (114 mm) deep (1-1/2 times 3 in (76 mm)). For a 24 in (610 mm) high block, the shear heels are 6 in (152 mm) deep (2 times 3 in (76 mm)).

To ensure proper wall alignment and to account for the multiple height blocks and varying setbacks, you have to adjust the bottom row of blocks based on their height. Setup a traditional string line for the back of the wall, then offset the blocks per the detail at the bottom of this page.

OUTCROPPING OFFSET BY HEIGHT ILLUSTRATION

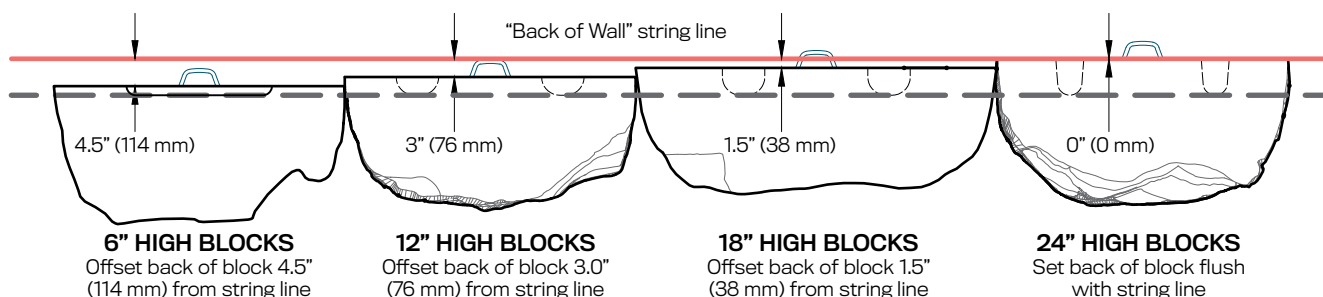



GRAND LEDGE™

FEATURES

- The look of natural ledgestone: bold in scale, with consistent dimensions for faster installation
- 24 unique wall textures
- Quality material equals long term durability
- Four additional 5-sided blocks can be used as 90-degree returns
- Engineerable wall system with capabilities of 5' to 6' gravity walls with optimal site conditions

MATERIAL WETCAST

Refer to our website for preliminary height guides and the most recent color offerings.

Dimensions are nominal.

Specifications are subject to change.

There is a minimum 30-ft radius for convex curves created with Grand Ledge™.



Learn More

WALL PALLET

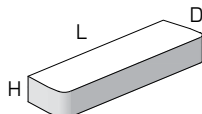
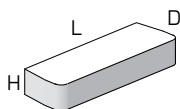
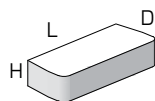
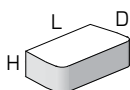
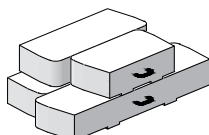

Weight: 4,000± lbs (inc. pallet)
 Coverage: 18 face feet
 Pieces Per Pallet: 4

UNIT: 3'

Dimensions: 36"L x 20"D x 12"H
 Weight: 650± lbs
 Units Per Pallet: 1

UNIT: 4'

Dimensions: 48"L x 20"D x 12"H
 Weight: 865± lbs
 Units Per Pallet: 1

UNIT: 5'

Dimensions: 60"L x 20"D x 12"H
 Weight: 1,085± lbs
 Units Per Pallet: 1

UNIT: 6'

Dimensions: 72"L x 20"D x 12"H
 Weight: 1,300± lbs
 Units Per Pallet: 1

CORNER PALLET

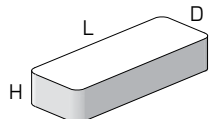
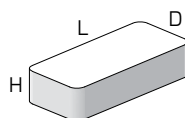
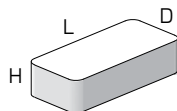
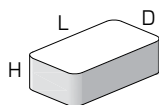
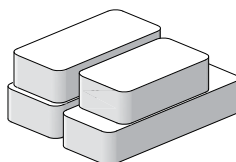

Weight: 3,350± lbs (inc. pallet)
 Coverage: 21.6 face feet
 14.9 linear feet (freestanding)
 Pieces Per Pallet: 4 (one of each unit)

CORNER UNIT: 1

Dimensions: 36"L x 20"D x 12"H
 Weight: 623± lbs
 Units Per Pallet: 1

CORNER UNIT: 2

Dimensions: 42.75"L x 19.75"D x 12"H
 Weight: 760± lbs
 Units Per Pallet: 1

CORNER UNIT: 3

Dimensions: 46"L x 21"D x 12"H
 Weight: 880± lbs
 Units Per Pallet: 1

CORNER UNIT: 4

Dimensions: 54"L x 20"D x 12"H
 Weight: 963± lbs
 Units Per Pallet: 1

GENERAL NOTES FOR WALL SECTIONS

This page shows typical construction details for Grand Ledge™ walls. These drawings are representative of major components required in wall construction. Specific details including reinforcement layers, drainage details, soil requirements, etc. shall be per engineered design for wall. For more cross-section and design options, visit our website.

- These drawings are for preliminary reference only (not for final construction).
- Final designs for construction must be prepared by a registered professional engineer using the actual conditions of the proposed site and loads.
- Final wall design must address both internal and external drainage and shall be evaluated by the professional engineer who is responsible for the wall design.
- Block size and placement shown are for reference only individual Grand Ledge™ blocks will vary with installation pattern.

TYPICAL GRAVITY RETAINING WALL DETAIL

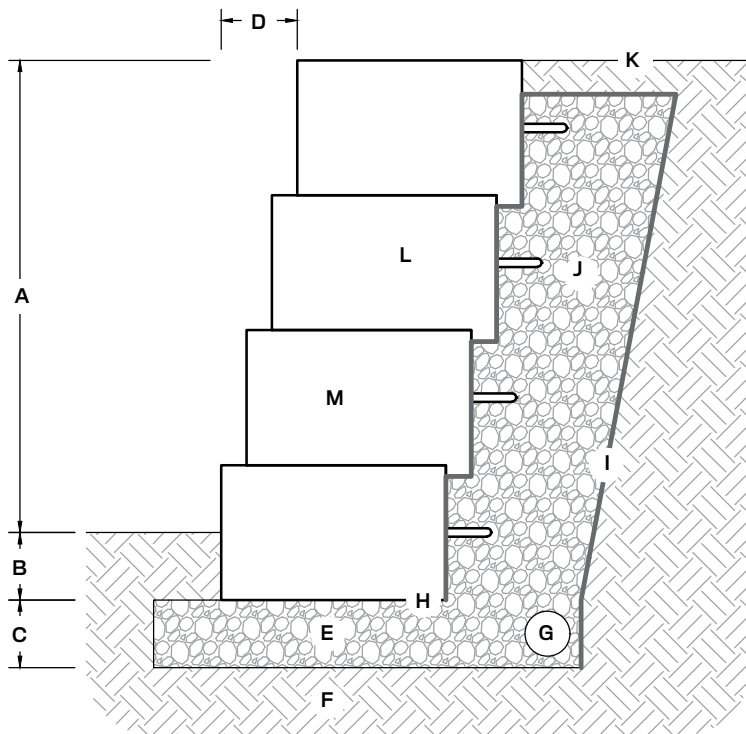

- A. Exposed height (varies)
- B. Bury depth (varies by design, min. 6")
- C. Leveling pad depth (varies by design, min. 6")
- D. Horizontal setback, 2-1/4" setback per 12" vertical (10.6° batter angle on wall)
- E. Crushed stone leveling pad
- F. Foundation soil compacted to 95% max. dry density
- G. 4" corrugated perforated drain pipe
- H. Shear heel removed from base block (optional)
- I. Non-woven geotextile fabric
- J. Drainstone (ASTM #57), min. 12" behind wall
- K. Finish grade to drain away from the wall
- L. Wall blocks
- M. Place 12" by 18" strip of geotextile fabric in V-shaped joint between blocks

TYPICAL FREESTANDING WALL DETAIL

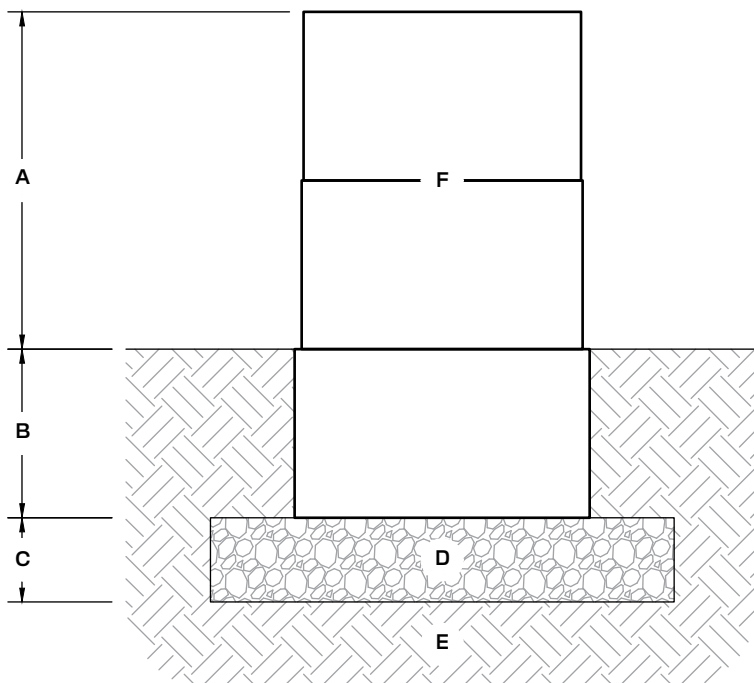

- A. Exposed height (varies, max. 24")
- B. Bury depth (min. 6")
- C. Leveling pad depth (min. 6")
- D. Crushed stone leveling pad
- E. Foundation soil compacted to 95% max. dry density
- F. Freestanding wall blocks

GENERAL NOTES FOR WALL SECTIONS

This page shows typical construction details for Grand Ledge™ walls. These drawings are representative of major components required in wall construction. Specific details including reinforcement layers, drainage details, soil requirements, etc. shall be per engineered design for wall. For more cross-section and design options, visit our website.

- These drawings are for preliminary reference only (not for final construction).
- Final designs for construction must be prepared by a registered professional engineer using the actual conditions of the proposed site and loads.
- Final wall design must address both internal and external drainage and shall be evaluated by the professional engineer who is responsible for the wall design.
- Block size and placement shown are for reference only individual Grand Ledge™ blocks will vary with installation pattern.

TYPICAL REINFORCED RETAINING WALL DETAIL

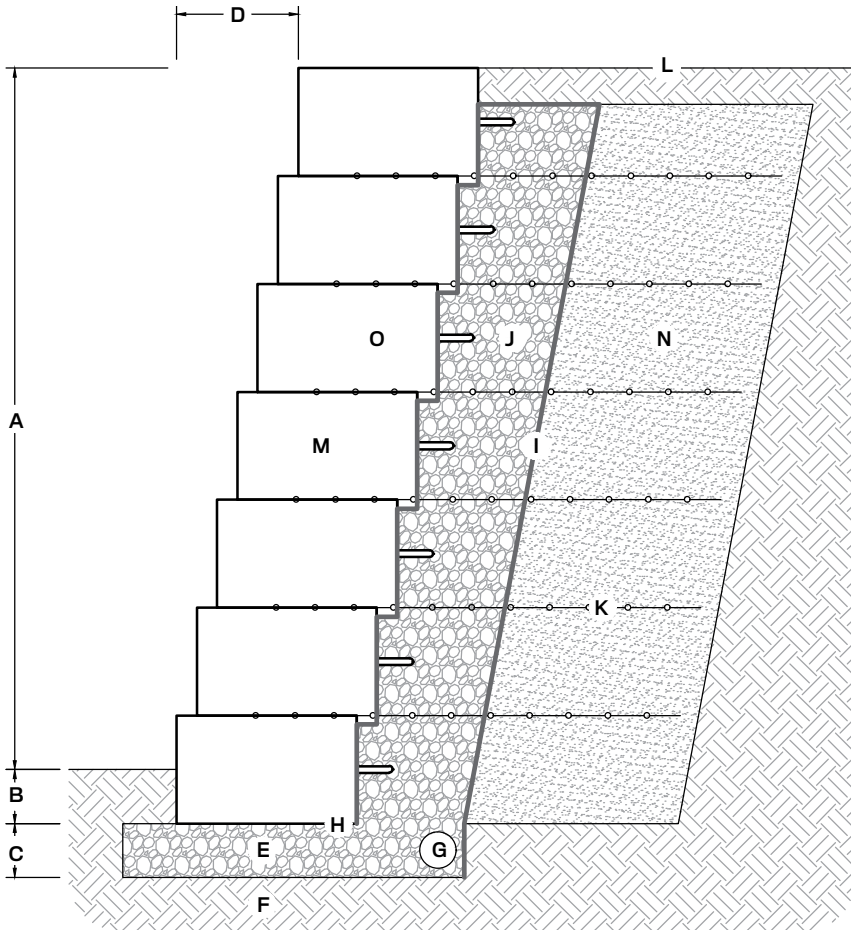

- A. Exposed height (varies by design)
- B. Bury depth (varies by design, min 6")
- C. Leveling pad depth (varies by design, min. 6")
- D. Horizontal setback, 2-1/4" per 12" vertical (10.6° batter angle on wall)
- E. Crushed stone leveling pad
- F. Foundation soil compacted to 95% max. dry density
- G. 4" corrugated perforated drain pipe
- H. Shear heel removed from base block (optional)
- I. Non-woven geotextile fabric
- J. Drainstone (ASTM #57), min. 12" behind wall
- K. Geogrid reinforcement placed between blocks (length, vertical placement, and geogrid type varies by design)
- L. Finish grade to drain away from the wall
- M. Wall blocks
- N. Reinforced soil compacted to 95% max. dry density
- O. Place 12" by 18" strip of geotextile fabric in V-shaped joint between blocks

GENERAL NOTES FOR WALL SECTIONS

This page shows typical construction details for Grand Ledge™ walls. These drawings are representative of major components required in wall construction. Specific details including reinforcement layers, drainage details, soil requirements, etc. shall be per engineered design for wall. For more cross-section and design options, visit our website.

- These drawings are for preliminary reference only (not for final construction).
- Final designs for construction must be prepared by a registered professional engineer using the actual conditions of the proposed site and loads.
- Final wall design must address both internal and external drainage and shall be evaluated by the professional engineer who is responsible for the wall design.
- Block size and placement shown are for reference only individual Grand Ledge™ blocks will vary with installation pattern.

TYPICAL GRAVITY RETAINING WALL DETAIL WITH AGGREGATE WEDGE BACKFILL

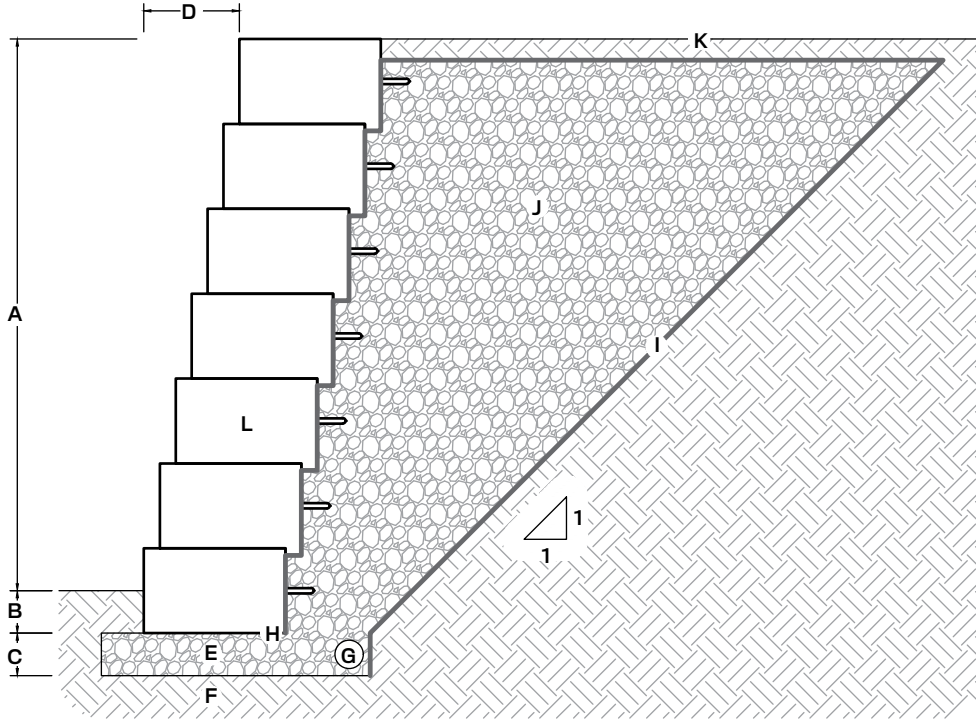

- A. Exposed height (varies by design)
- B. Bury depth (varies by design, min. 6")
- C. Leveling pad depth (varies by design, min. 6")
- D. Horizontal setback, 2-1/4" per 12" vertical (10.6° batter angle on wall)
- E. Crushed stone leveling pad
- F. Foundation soil compacted to 95% max. dry density
- G. 4" corrugated perforated drain pipe
- H. Shear heel removed from base block (optional)
- I. Non-woven geotextile fabric
- J. Drainstone (ASTM #57), min. 12", installed on a 1H:1V slope behind wall
- K. Finish grade to drain away from the wall
- L. Wall blocks

TYPICAL RETAINING WALL DETAIL WITH CAST-IN-PLACE CONCRETE BACKFILL

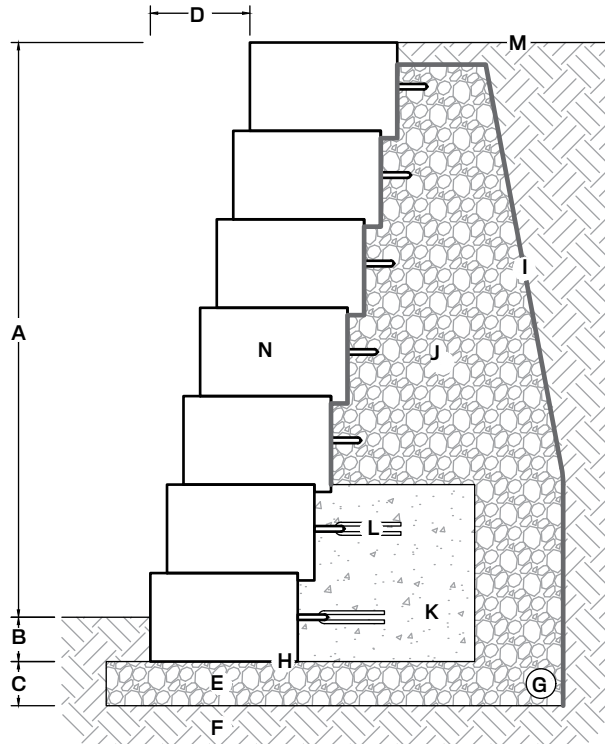

- A. Exposed height (varies by design)
- B. Bury depth (varies by design, min. 6")
- C. Leveling pad depth (varies by design, min. 6")
- D. Horizontal setback, 2-1/4" per 12" vertical (10.6° batter angle on wall)
- E. Crushed stone leveling pad
- F. Foundation soil compacted to 95% max. dry density
- G. 4" corrugated perforated drain pipe
- H. Shear heel removed from base block (optional)
- I. Non-woven geotextile fabric
- J. Drainstone (ASTM #57), min. 12" behind wall and cast-in-place concrete
- K. Cast-in-place ready-mix concrete, min. 2,500 psi (height and depth vary by design)
- L. #4 Rebar, 18" lengths bent in half (9" embedment), installed on every loop
- M. Finish grade to drain away from the wall
- N. Wall blocks



OUTCROPPING

FEATURES

- Beautiful weathered stone textures and natural color blends
- Consistent dimensions equals fast installation
- Quality materials equals long term durability
- Freestanding units have five-sided surface texture to allow for freestanding (two-sided) installations or as a top course on an Outcropping retaining wall
- Corner blocks help make a 90° corner with four-sided surface texture and can be installed with alternating faces exposed to maintain a more random look
- Galvanized steel hooks are available and required for reinforced walls

MATERIAL WETCAST

Refer to our website for the most recent color offerings, custom layout software for installation and preliminary height guides.

Outcropping pallets are sold in full pallet quantities only, individual sizes cannot be requested.

Actual weight and color may vary.



Learn More

CORNER PALLET: 6"

Weight: 2,015± lbs (inc. pallet)
Coverage: 11 sq ft
Units Per Pallet: 4

Product depth nominally 27".

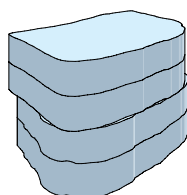

6"H 39"L

UNIT: CORNER 6"
Weight: 480± lbs

CORNER PALLET: 12"

Weight: 3,600± lbs (inc. pallet)
Coverage: 19.5 sq ft
Units Per Pallet: 3

Product depth nominally 30".

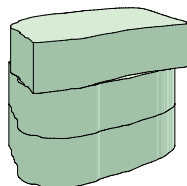

12"H 48"L

UNIT: CORNER 12"
Weight: 1,170± lbs

CORNER NOTES

- Two 6" high corner blocks are typically stacked on top of each other and placed on top of a 12" block.

OUTCROPPING

RETAINING PALLET: A

Weight: 4,000± lbs (inc. pallet)
 Coverage : 18 sq ft
 Units Per Pallet: 4 (1 of each)

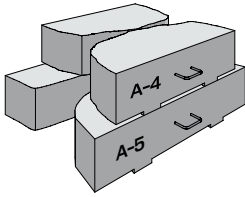

Product depth ranges nominally from 18" - 24" for Retaining Wall units.

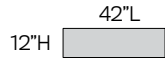

UNIT: 3.5 X 1
 Weight: 750± lbs



UNIT: 5 X 1
 Weight: 1,100± lbs

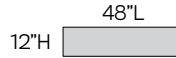

UNIT: 4 X 1
 Weight: 900± lbs

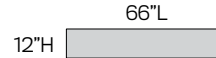

UNIT: 5.5 X 1
 Weight: 1,150± lbs

RETAINING PALLET: B

Weight: 4,000± lbs (inc. pallet)
 Coverage : 18 sq ft
 Units Per Pallet: 6 (1 of each)

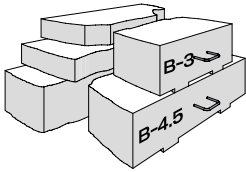

Product depth ranges nominally from 18" - 24" for Retaining Wall units.

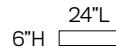

UNIT: 2 X .5
 Weight: 250± lbs

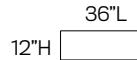

UNIT: 3 X 1
 Weight: 620± lbs

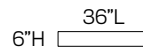

UNIT: 3 X .5
 Weight: 320± lbs



UNIT: 4.5 X 1
 Weight: 950± lbs

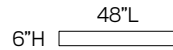

UNIT: 4 X .5
 Weight: 450± lbs

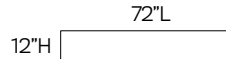

UNIT: 6 X 1
 Weight: 1,300± lbs

RETAINING PALLET: C

Weight: 4,000± lbs (inc. pallet)
 Coverage : 18 sq ft
 Units Per Pallet: 4 (1 of each)

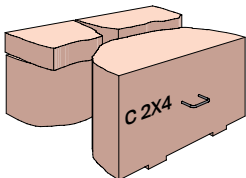

Product depth ranges nominally from 18" - 24" for Retaining Wall units.

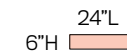

UNIT: 2 X .5
 Weight: 250± lbs

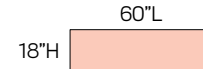

UNIT: 5 X 1.5
 Weight: 1,600± lbs

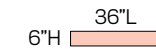

UNIT: 3 X .5
 Weight: 320± lbs

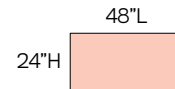

UNIT: 4 X 2
 Weight: 1,800± lbs

FREESTANDING PALLET: D

Weight: 3,150± lbs (inc. pallet)
 Coverage: 11 sq ft
 Units Per Pallet: 3 (1 of each)

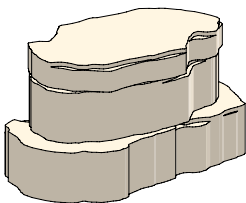

Product depth nominally 30" for Freestanding Wall units.

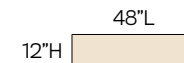

UNIT: 4 X 1
 Weight: 1,080± lbs



UNIT: 5 X 1
 Weight: 1,540± lbs

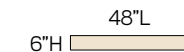

UNIT: 4 X .5
 Weight: 460± lbs

FREESTANDING PALLET: E

Weight: 3,450± lbs (inc. pallet)
 Coverage: 10.5 sq ft
 Units Per Pallet: 3 (1 of each)

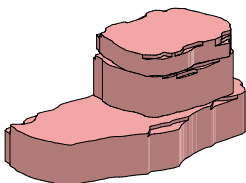

Product depth nominally 30" for Freestanding Wall units.

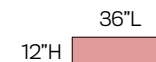

UNIT: 3 X 1
 Weight: 880± lbs

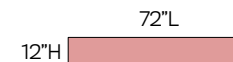

UNIT: 6 X 1
 Weight: 2,080± lbs



UNIT: 3 X .5
 Weight: 440± lbs

OUTCROPPING

RETAINING WALL PATTERNS, 90 SQ FT

(2 PALLET A, 2 PALLET B AND 1 PALLET C)

Please note that the length dimensions shown for Outcropping blocks are rounded for reference. The actual length of the constructed wall will vary slightly from the pattern dimensions shown. Block size and placement shown are for reference only. Individual Outcropping blocks will vary with installation pattern. For more information visit highformat.com

45'L X 2'H

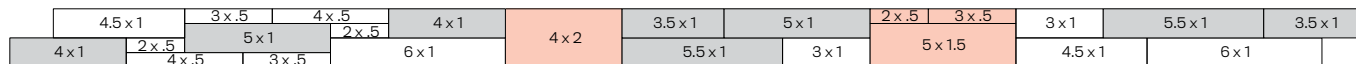

30'L X 3'H

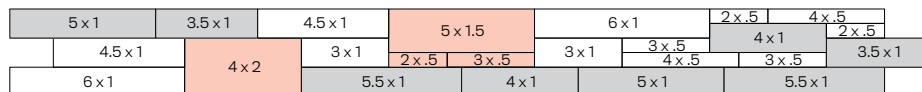

22.5'L X 4'H

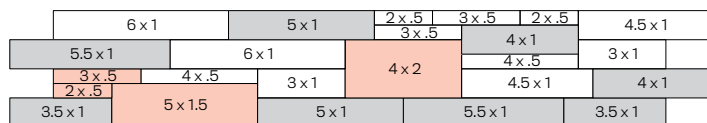

18'L X 5'H

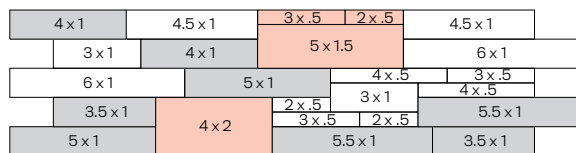

90° CORNER WALL

Outcropping has two corner blocks to help make a 90° corner in the wall. The corner blocks are four-sided, and can be installed with alternating faces exposed to maintain a more random look.

The size of the corner blocks have been chosen to account for the wall batter in both directions. Two 6" high corner blocks are typically stacked on top of each other and placed on top of a 12" block. The corner blocks are intended to be stepped back 3" in both directions per course. In a few areas, you may need to trim a small part of the corner blocks near the back of the wall to avoid interference with the shear heels on adjacent blocks. See the pattern shown here, which details how to make a 90° corner with (4) A Pallets, (4) B Pallets, (2) C Pallets, (3) 12" Corner Blocks and (4) 6" Corner Blocks.

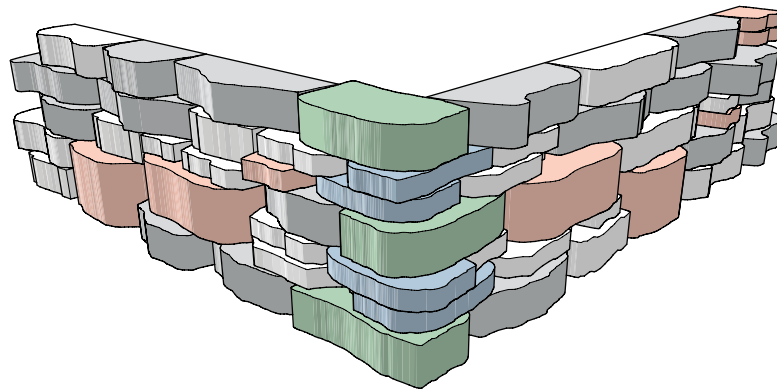
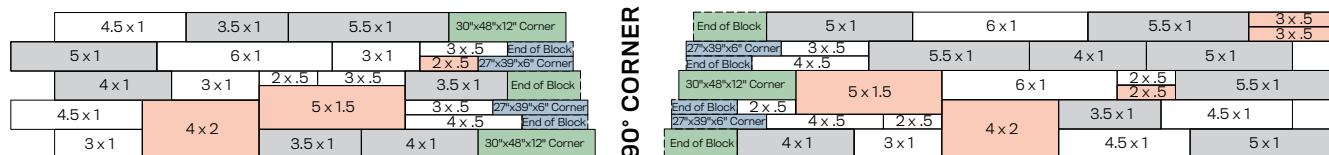

CURVES

Outcropping Blocks have shear heels to help with wall integrity and provide a setback from lower blocks in the wall, thus causing the wall to batter back. The batter is important to the engineering design of the wall, and it must be accounted for during construction of a curved wall section.

OUTSIDE (CONVEX) CURVE

If you are constructing an outside (convex) curve, the wall batter will cause the blocks higher in the wall to have a shorter radius around the curve than lower blocks. This will cause the higher blocks to "grow" in the wall layout pattern. (This is similar in concept to the inside lane of a race track being shorter than the outside lane). The result is a potential overlap between some of the blocks in the wall. The best way to deal with this overlap is to saw cut the end of the smaller block, which allows the blocks to fit tight together and all the shear heels to be properly engaged. This saw cut is typically made on an angle to match the taper on the block you are abutting.

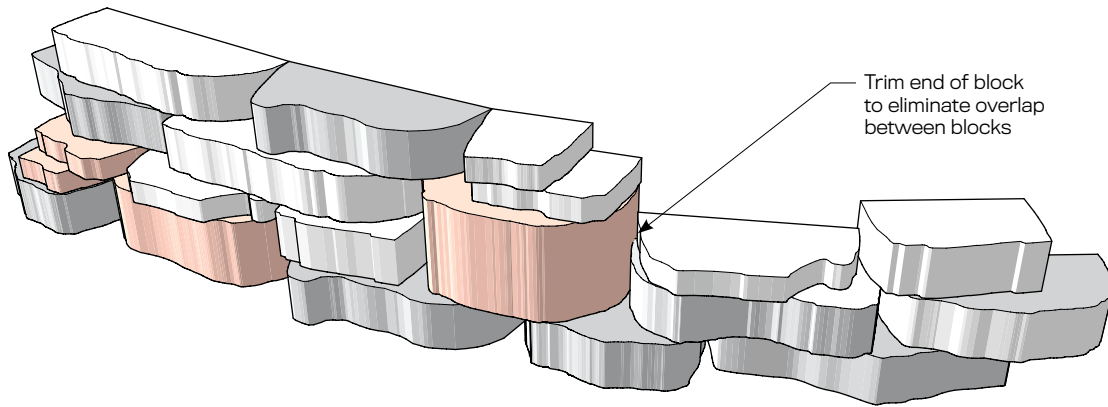

INSIDE (CONCAVE) CURVE

If you are constructing an inside (concave) curve, the wall batter will cause the block higher in the wall to have a longer radius around the curve than lower blocks. The important step when constructing an inside curve is to keep all blocks tight together. In most cases, the blocks will touch somewhere along the sides of the blocks, not at the back of the blocks. If needed, you can trim the ends off some blocks to prevent gaps from opening up between blocks. When constructing a curve with a short radius, voids may form at the back of the wall where two blocks meet. If this happens simply fill the void areas with filter fabric and drainstone. Additionally, gaps in concave walls can be secured pre-emptively by placing a layer of non-woven geotextile fabric against the backside of the block before installation of drainstone behind the wall.

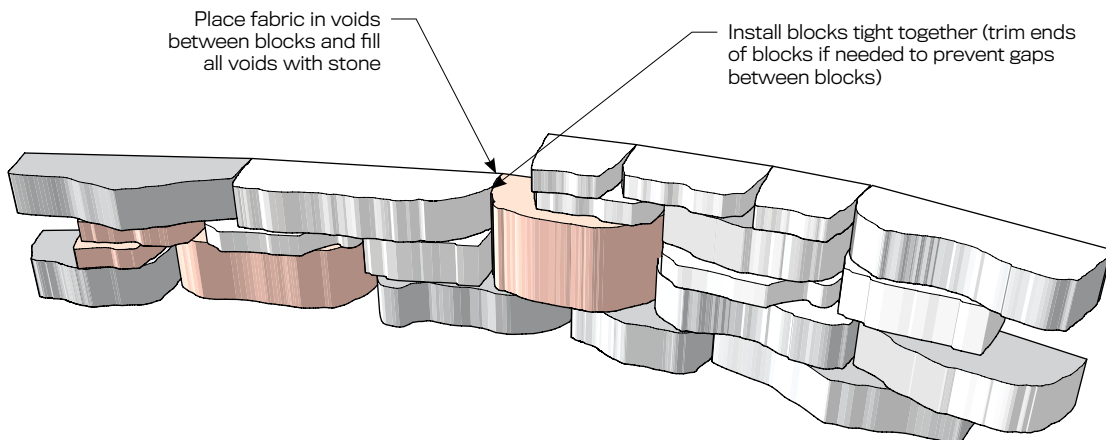

GENERAL NOTES FOR WALL SECTIONS

This page shows typical construction details for Outcropping walls. These drawings are representative of major components required in wall construction. Specific details including geotextile reinforcement layers, drainage details, soil requirements, etc. shall be per engineered design for wall. For more cross-section and design options, visit our website.

- These drawings are for preliminary reference only (not for final construction).
- Final designs for construction **must be prepared by a registered professional engineer** using the actual conditions of the proposed site and loads.
- Block size and placement shown are for reference only, individual Outcropping blocks will vary with installation pattern.

TYPICAL GRAVITY RETAINING WALL DETAIL

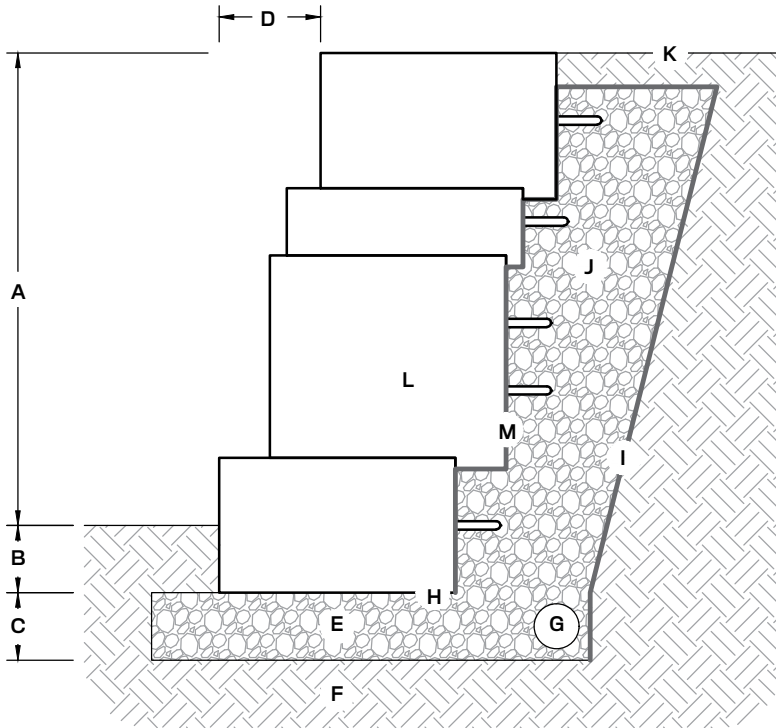

- A. Exposed height (varies by design)
- B. Bury depth (varies by design, min. 6")
- C. Leveling pad depth (varies by design, min. 6")
- D. Horizontal setback, 3" per 12" vertical (14° batter angle on wall)
- E. Crushed stone leveling pad
- F. Foundation soil compacted to 95% max. dry density
- G. 4" corrugated perforated drain pipe
- H. Shear heel removed from base block (optional)
- I. Non-woven geotextile fabric
- J. Drainstone (ASTM #57), min. 12" behind wall
- K. Finish grade to drain away from the wall
- L. Wall blocks
- M. Non-woven geotextile fabric at back of blocks and top of drainstone (required)

TYPICAL FREESTANDING WALL DETAIL

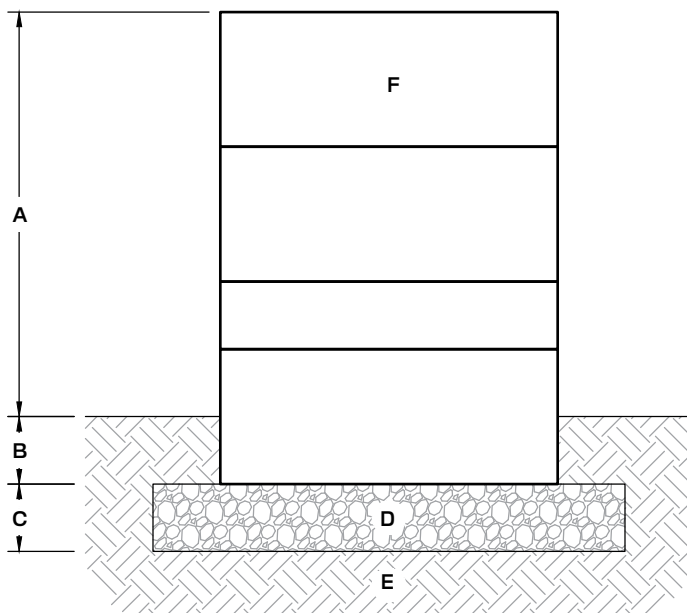

- A. Exposed height (varies, max. 36")
- B. Bury depth (min. 6")
- C. Leveling pad depth (min. 6")
- D. Crushed stone leveling pad
- E. Foundation soil compacted to 95% max. dry density
- F. Freestanding wall blocks

GENERAL NOTES FOR WALL SECTIONS

This page shows typical construction details for Outcropping walls. These drawings are representative of major components required in wall construction. Specific details including geotextile reinforcement layers, drainage details, soil requirements, etc. shall be per engineered design for wall. For more cross-section and design options, visit our website.

- These drawings are for preliminary reference only (not for final construction).
- Final designs for construction must be prepared by a registered professional engineer using the actual conditions of the proposed site and loads.
- Block size and placement shown are for reference only, individual Outcropping blocks will vary with installation pattern.

TYPICAL GRAVITY RETAINING WALL DETAIL WITH AGGREGATE WEDGE BACKFILL

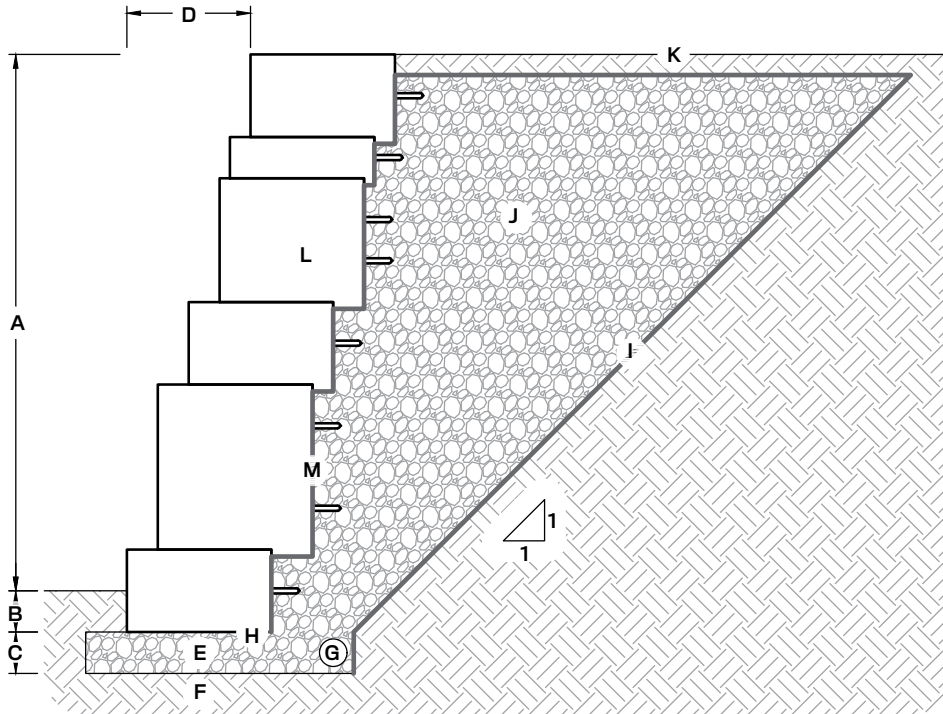

- A.** Exposed height (varies by design)
- B.** Bury depth (varies by design, min. 6")
- C.** Leveling pad depth (varies by design, min. 6")
- D.** Horizontal setback, 3" per 12" vertical (14° batter angle on wall)
- E.** Crushed stone leveling pad
- F.** Foundation soil compacted to 95% max. dry density
- G.** 4" corrugated perforated drain pipe
- H.** Shear heel removed from base block (optional)
- I.** Non-woven geotextile fabric
- J.** Drainstone (ASTM #57), min. 12", installed on a 1H:1V slope behind wall
- K.** Finish grade to drain away from the wall
- L.** Wall blocks
- M.** Non-woven geotextile fabric at back of blocks and top of drainstone (required)

OUTCROPPING

GENERAL NOTES FOR WALL SECTIONS

This page shows typical construction details for Outcropping walls. These drawings are representative of major components required in wall construction. Specific details including geotextile reinforcement layers, drainage details, soil requirements, etc. shall be per engineered design for wall. For more cross-section and design options, visit our website.

- These drawings are for preliminary reference only (not for final construction).
- Final designs for construction must be prepared by a registered professional engineer using the actual conditions of the proposed site and loads.
- Block size and placement shown are for reference only, individual Outcropping blocks will vary with installation pattern.

TYPICAL RETAINING WALL DETAIL WITH SOIL REINFORCEMENT

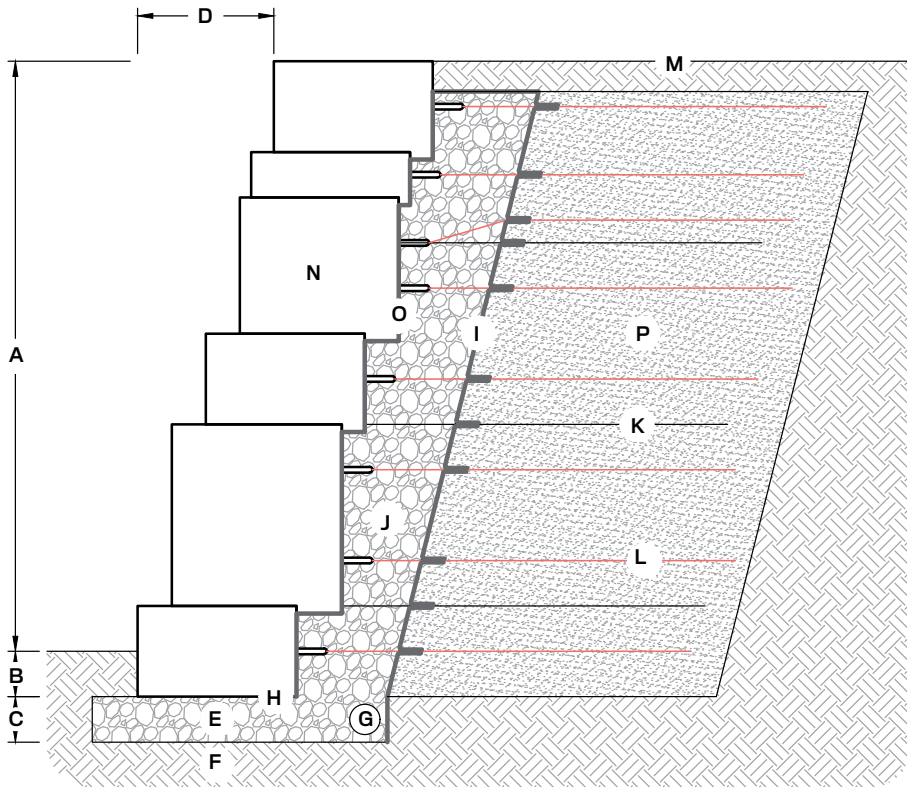

- A. Exposed height (varies by design)
- B. Bury depth (varies by design, min. 6")
- C. Leveling pad depth (varies by design, min. 6")
- D. Horizontal setback, 3" per 12" vertical (14° batter angle on wall)
- E. Crushed stone leveling pad
- F. Foundation soil compacted to 95% max. dry density
- G. 4" corrugated perforated drain pipe
- H. Shear heel removed from base block (optional)
- I. Non-woven geotextile fabric (recommended)
- J. Drainstone (ASTM #57), min. 12" behind wall
- K. Geogrid, abutting the backside of the block (length, vertical placement, and geogrid type varies by design)
- L. Paraweb strap installed on every loop (embedment depth varies by design, maintain min. 3" vertical space from geogrid)
- M. Finish grade to drain away from the wall
- N. Wall blocks
- O. Non-woven geotextile fabric at back of blocks and top of drainstone (required)
- P. Reinforced soil compacted to 95% max. dry density

TYPICAL PARAWEB STRAP CONNECTION DETAIL

PLAN VIEW

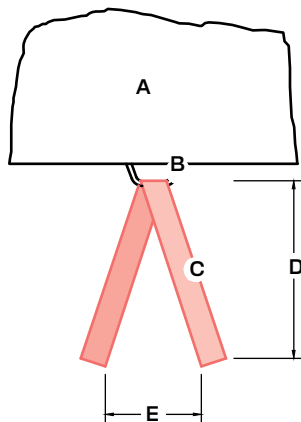

SIDE PROFILE VIEW

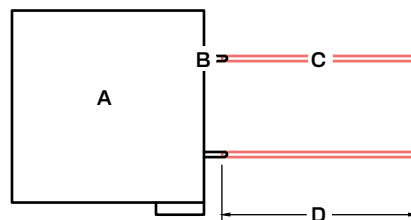

- A. Outcropping wall block
- B. Galvanized lift hook (required)
- C. Paraweb strap (required for each lift hook)
- D. Strap embedment depth (varies per design)
- E. 12-24" separation between straps ends

GENERAL NOTES FOR WALL SECTIONS

This page shows typical construction details for Outcropping walls. These drawings are representative of major components required in wall construction. Specific details including geotextile reinforcement layers, drainage details, soil requirements, etc. shall be per engineered design for wall. For more cross-section and design options, visit our website.

- These drawings are for preliminary reference only (not for final construction).
- Final designs for construction must be prepared by a registered professional engineer using the actual conditions of the proposed site and loads.
- Block size and placement shown are for reference only, individual Outcropping blocks will vary with installation pattern.

TYPICAL RETAINING WALL DETAIL WITH CAST-IN-PLACE CONCRETE BACKFILL

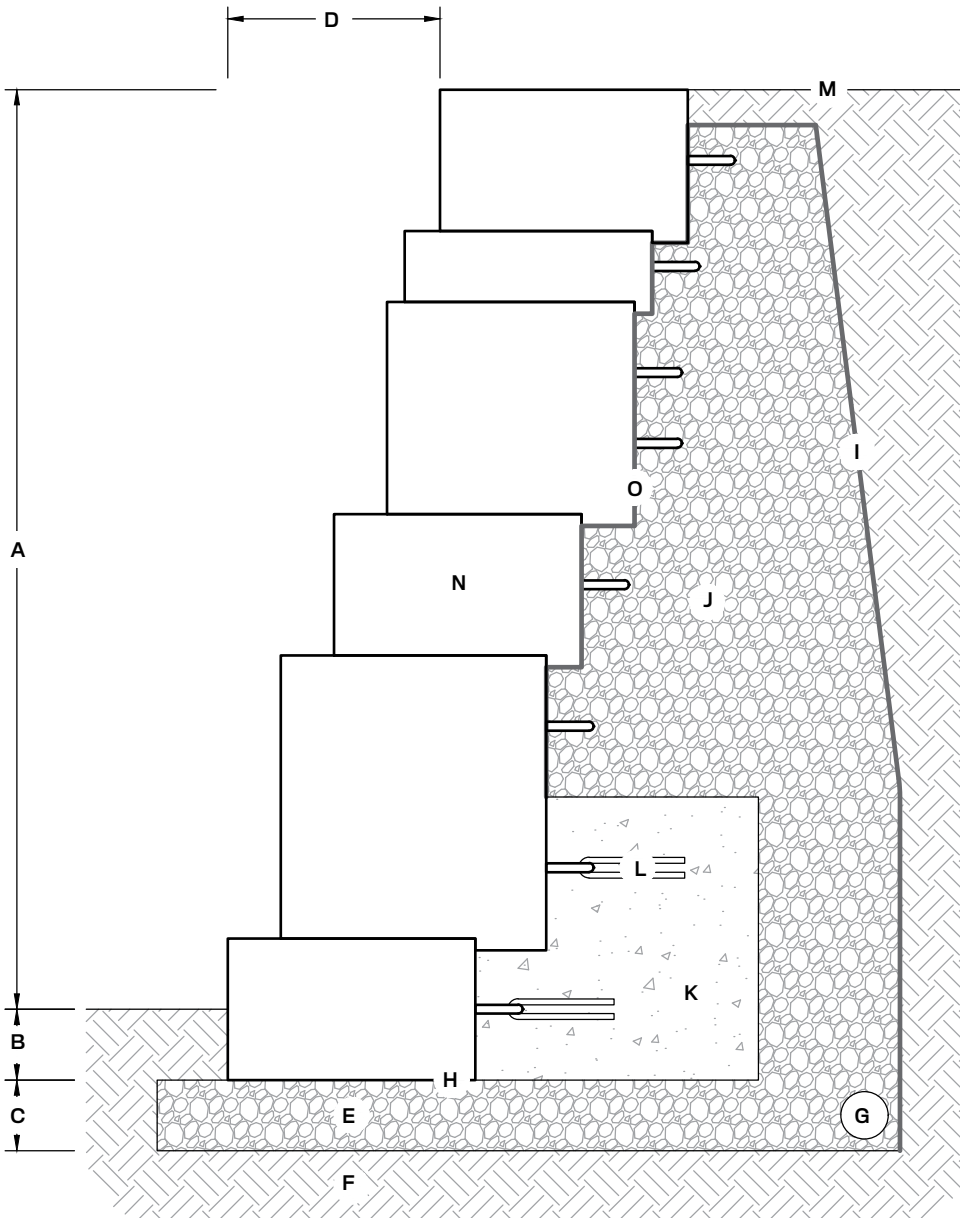

- A. Exposed height (varies by design)
- B. Bury depth (varies by design, min. 6")
- C. Leveling pad depth (varies by design, min. 6")
- D. Horizontal setback, 3" setback per 12" vertical (14° batter angle on wall)
- E. Crushed stone leveling pad
- F. Foundation soil compacted to 95% max. dry density
- G. 4" corrugated perforated drain pipe
- H. Shear heel removed from base block (optional)
- I. Non-woven geotextile fabric
- J. Drainstone (ASTM #57), min. 12" behind wall and cast-in-place concrete
- K. Cast-in-place Redi-mix concrete, min. 2,500 psi (height & depth vary by design)
- L. #4 rebar, 18" lengths bent in half (9" embedment), installed on every loop
- M. Finish grade to drain away from the wall
- N. Wall blocks
- O. Non-woven geotextile fabric at back of blocks and top of drainstone (required)

KODAH®

FEATURES

- Unique large scale with modern, linear proportions
- Multiple face textures for each block size creates a natural quarried and random look
- Retaining walls and double-sided freestanding walls possible with the wall block (blocks are finished on both the front and back faces and are tapered on each side approximately 1.5" from the front to the back of the block)
- Corner blocks can be used to construct columns, provide a finished end on a freestanding wall, and make 90° corners (blocks are finished on three sides, and the fourth side is tapered to fit with the other wall blocks)

MATERIAL WETCAST

Refer to our website for preliminary height guides and the most recent color offerings.



Learn More

WALL PALLET

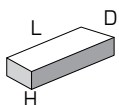
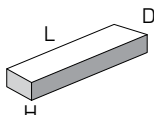
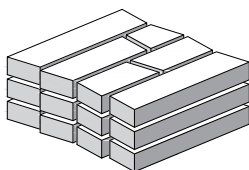

Block dimensions are nominal.

Weight:	2,500± lbs (inc. pallet)
Coverage (Retaining):	21 sq ft
Coverage (Freestanding):	20 sq ft
Layers Per Pallet:	3
Section:	7 sq ft per layer

UNIT: 1

Dimensions:	42"L x 10.5"D x 6"H
Weight:	200± lbs
Units Per Pallet:	6

UNIT: 2

Dimensions:	30"L x 10.5"D x 6"H
Weight:	140± lbs
Units Per Pallet:	3

UNIT: 3

Dimensions:	21"L x 10.5"D x 6"H
Weight:	100± lbs
Units Per Pallet:	6

UNIT: 4

Dimensions:	12"L x 10.5"D x 6"H
Weight:	50± lbs
Units Per Pallet:	3

CORNER PALLET

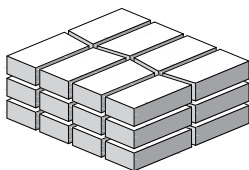

Block dimensions are nominal.

Weight:	2,500± lbs (inc. pallet)
Coverage:	31.5 sq ft
Layers Per Pallet:	3
Section:	1.3 sq ft per piece

CORNER UNIT

Dimensions:	21"L x 10.5"D x 6"H
Weight:	100± lbs
Units Per Pallet:	24 (12 left, 12 right)

CURVES

This page shows typical construction details for making curved walls with Kodah® blocks. The taper sides of the blocks allow for construction of a wide range of curves in both retaining and freestanding walls. Walls are shown below without batter for clarity. Blocks in a retaining wall should be adjusted slightly in place and trimmed as needed to allow wall construction with proper batter.

- Minimum radius curves are shown which can be constructed without saw cutting a significant number of blocks. Larger radius curves can be created by leaving a larger gap between blocks on the back side of the wall. The gaps must be filled with drainstone.
- When retaining walls are constructed with batter, the radius on outside curves becomes smaller with each course due to the block setback. For proper construction, the radius of the bottom course must be larger than the minimum radius so upper courses will have sufficient room for construction.
- When retaining walls are constructed with a batter, the radius on inside curves becomes larger with each course due to the block setback.

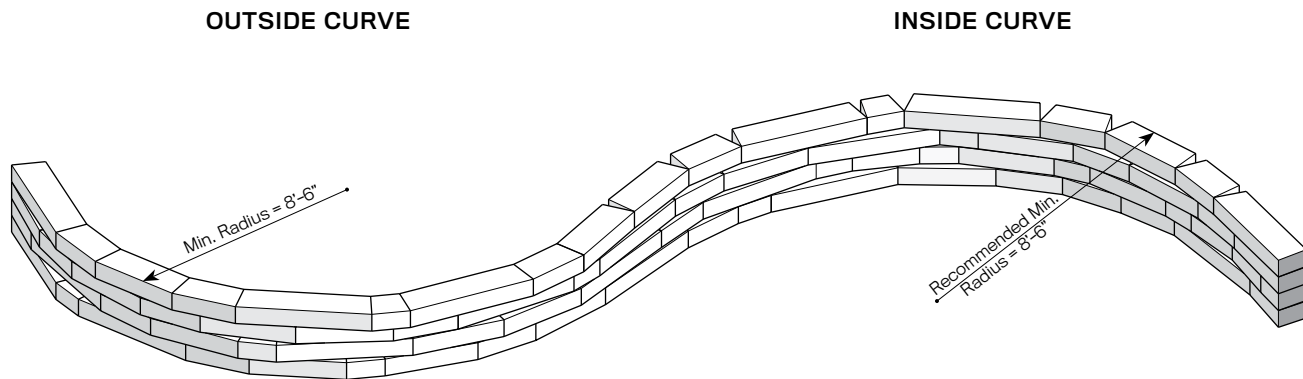

COLUMNS

Kodah® columns can be constructed utilizing 1 full pallet of Kodah® corner blocks. A 34" column cap can be utilized to finish the column. The column cap can be cored as needed to accommodate the installation of a lamp.

Step 1

Place (4) Kodah® corner blocks with the same taper, facing into the center of the column.

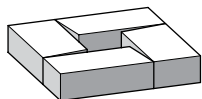

Step 2

Place a second row of (4) Kodah® corner blocks with the opposite taper, facing into the center of the column.

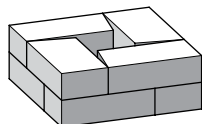

Step 3

Continue with subsequent rows to the desired column height. One pallet of corner blocks will create a 32" x 32" x 36" tall column.

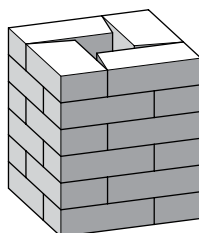

Step 4

Place a column cap to finish the column. The column cap can be cored as needed for installation of a light.

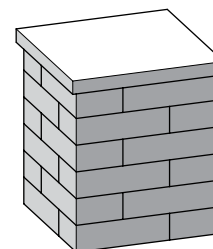

GENERAL NOTES FOR WALL SECTIONS

This page shows typical construction details for Kodah® walls. These drawings are representative of major components required in wall construction. Specific details including geotextile reinforcement layers, drainage details, soil requirements, etc. shall be per engineered design for wall.

- These drawings are for preliminary reference only (not for final construction).
- Final designs for construction must be prepared by a registered professional engineer using the actual conditions of the proposed site.
- Final wall design must address both internal and external drainage and shall be evaluated by the professional engineer who is responsible for the wall design.

TYPICAL FREESTANDING WALL DETAIL

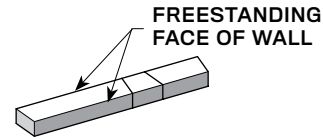
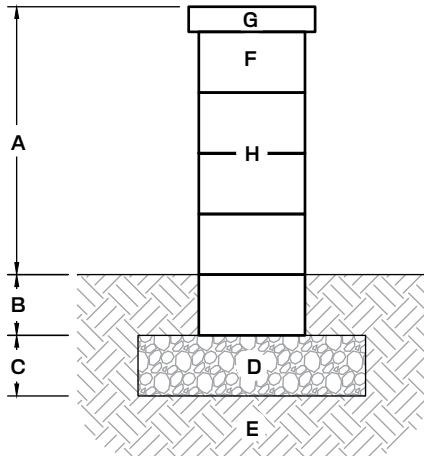

FREESTANDING FACE OF WALL

- A. Exposed height (varies, max. 24")
- B. Bury depth (min. 6")
- C. Leveling pad depth (min. 6")
- D. Crushed stone leveling pad
- E. Foundation soil compacted to 95% max. dry density
- F. Wall blocks
- G. Coping block
- H. Heavy Duty Construction Adhesive or One-Component, High Performance, Elastomeric Polyurethane Sealant required between all blocks and caps

TYPICAL GRAVITY RETAINING WALL DETAIL

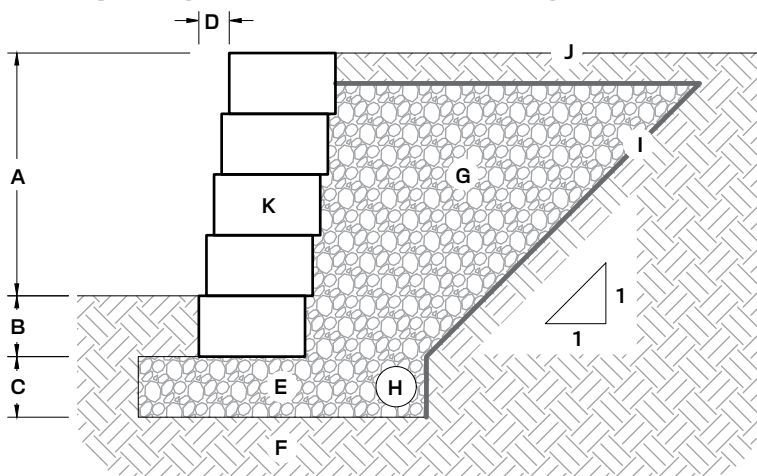

RETAINING BACK OF WALL
(Drainstone behind and between blocks)

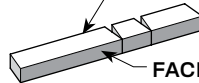

FACE OF WALL

- A. Exposed height (varies by design), 2' max. height without reinforcement
- B. Bury depth (varies by design, min. 6")
- C. Leveling pad depth (varies by design, min. 6")
- D. Recommended horizontal setback, 3/4" per 6" vertical (7° batter angle on wall)
- E. Crushed stone leveling pad
- F. Foundation soil compacted to 95% max. dry density
- G. Drainstone (ASTM #57), min. 12", on 1:1 slope behind wall
- H. 4" corrugated perforated drain pipe
- I. Non-woven geotextile fabric
- J. Finish grade to drain away from the wall
- K. Wall blocks

TYPICAL REINFORCED RETAINING WALL DETAIL

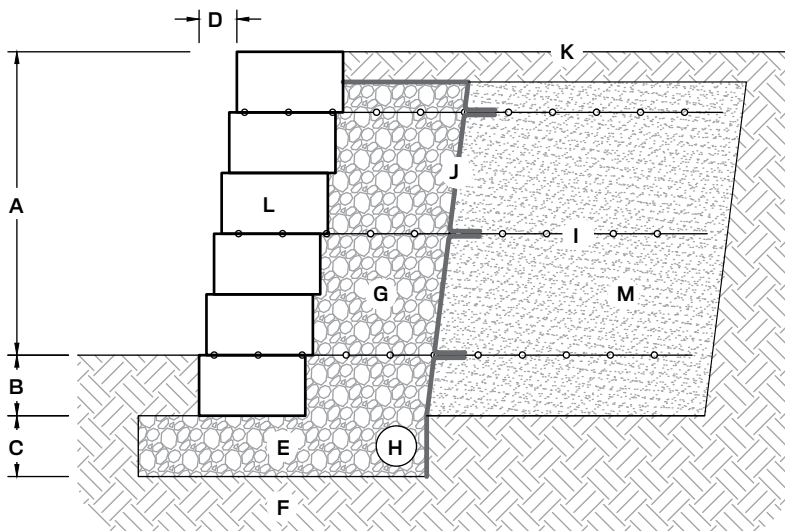

- A. Exposed height (varies by design)
- B. Bury depth (varies by design, min. 6")
- C. Leveling pad depth (varies by design, min. 6")
- D. Recommended horizontal setback, 3/4" per 6" vertical (7° batter angle on wall)
- E. Crushed stone leveling pad
- F. Foundation soil compacted to 95% max. dry density
- G. Drainstone (ASTM #57, min. 12" behind wall)
- H. 4" corrugated perforated drain pipe
- I. Geogrid reinforcement (lengths and vertical placement per design)
- J. Non-woven geotextile fabric
- K. Finish grade to drain away from the wall
- L. Wall blocks
- M. Reinforced soil compacted to 95% max. dry density



BELVEDERE®

FEATURES

- Natural stone texture on both the front and back with multiple face textures for each basic block size to provide a more random look
- Creates both freestanding and retaining walls
- Walls, columns, fire pits and more mean multiple creative possibilities
- Wall blocks are tapered on each side approximately 1" from the front to the back of the block
- Corner blocks are finished on three sides, the fourth side is tapered to fit with the wall blocks
- Corner blocks can be used to construct columns, create finished ends for walls, and make 90° corners
- Belvedere® Caps and Coping available to coordinate with wall product

MATERIAL WETCAST

Refer to our website for preliminary height guides and the most recent color offerings.

Average block weights of the different face texture patterns are shown. Weights of individual blocks may vary.



Learn More

WALL PALLET

Product depth nominally 9".

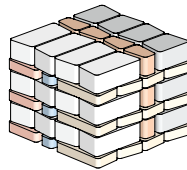

Weight: 2,475± lbs (inc. pallet)
 Coverage (Retaining): 27 sq ft
 Coverage (Freestanding): 25 sq ft
 Layers Per Pallet: 6
 Section: 9 sq ft per 2 layers
 (1 layer of 6", 1 layer of 3")

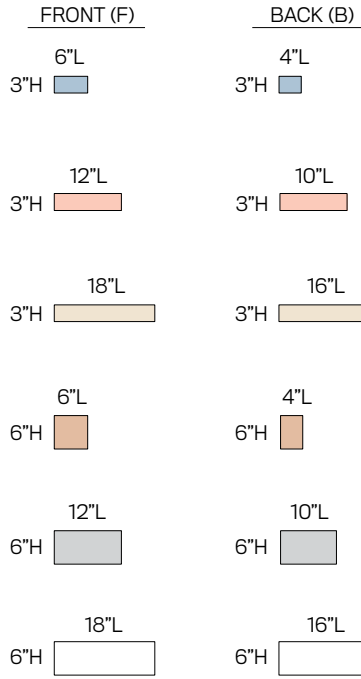

UNIT: 1
 Weight: 10± lbs
 Units Per Pallet: 12

UNIT: 2
 Weight: 20± lbs
 Units Per Pallet: 12

UNIT: 3
 Weight: 36± lbs
 Units Per Pallet: 12

UNIT: 4
 Weight: 21± lbs
 Units Per Pallet: 12

UNIT: 5
 Weight: 42± lbs
 Units Per Pallet: 12

UNIT: 6
 Weight: 67± lbs
 Units Per Pallet: 12

CORNER PALLET

Product depth nominally 9".

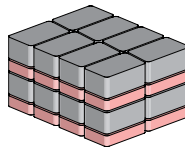

Weight: 1,520± lbs (inc. pallet)
 Coverage: 24 sq ft
 Layers Per Pallet: 4
 Section: 1.5 sq ft (one 6" piece, one 3" piece)

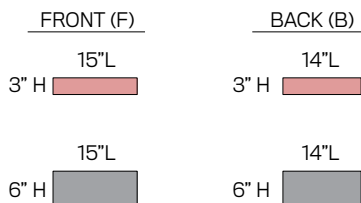

CORNER UNIT: 7
 Weight: 30± lbs
 Units Per Pallet: 16

CORNER UNIT: 8
 Weight: 58± lbs
 Units Per Pallet: 16

RETAINING WALL PATTERNS

Retaining walls are typically constructed with the front face of the block exposed. The v-shaped notches which appear on the back of wall between adjacent blocks must be filled with drainstone. The blocks shown below are labeled. For example, 4F would indicate the front (or longer) face of Unit 4, and 2B would indicate the back (or shorter) face of Unit 2.

12" HIGH

(12" high x 13'-6" wall section shown = 13.5 sq ft (1/2 wall pallet))

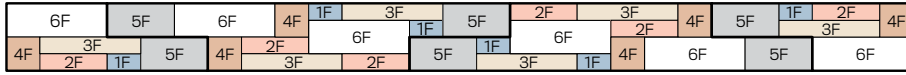

FACE OF WALL



BACK OF WALL

(Drainstone behind and between blocks)

18" HIGH

(18" high x 18'-0" wall section shown = 27 sq ft (1 wall pallet))

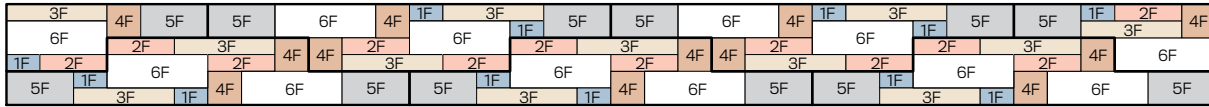

24" HIGH

(24" high x 16'-0" wall section shown = 32 sq ft (1.2 wall pallet))

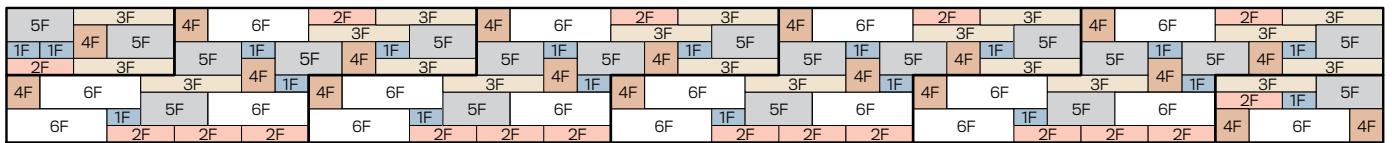

FREESTANDING WALL PATTERNS

24" PATTERN A

(Wall section shown = 24.67 sq ft (approx. 1 wall pallet))

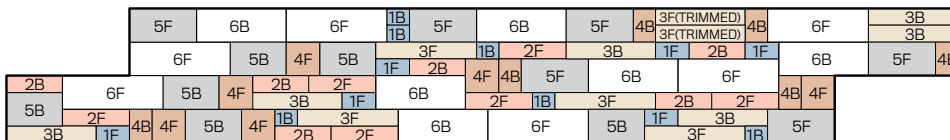

FACE OF WALL

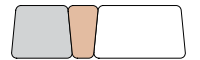

FACE OF WALL

Note: 2" must be trimmed from (2) 18"X3" blocks to make this pattern

24" PATTERN B

(Wall section shown = 24.67 sq ft (approx. 1 wall pallet))

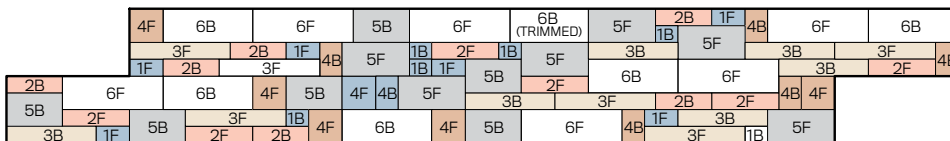

Note: 2" must be trimmed from (1) 18"X6" block to make this pattern

24" HIGH VERTICAL END: LEFT

(Wall section shown = 11.67 sq ft (1/2 wall pallet))

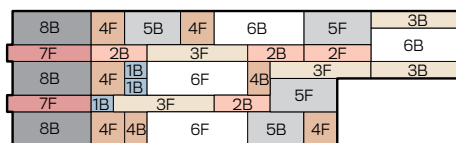

24" HIGH VERTICAL END: RIGHT

(Wall section shown = 11.67 sq ft (1/2 wall pallet))

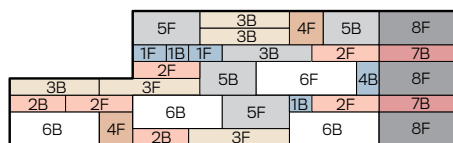

Note: For left and right ends, vertical end jogs in and out approximately 1" between blocks.

RETAINING WALL CURVES

This page shows typical construction details for making curved retaining walls with Belvedere® blocks. The taper on the side of the blocks allow for construction of a wide range of curves in both retaining and freestanding walls. Blocks in a retaining wall should be adjusted slightly in place and trimmed as needed to allow wall construction with proper batter. (For clarity, walls are shown below without batter.)

- Minimum radius curves are shown which can be constructed without saw cutting a significant number of blocks. Larger radius curves can be created by leaving a larger gap between blocks on the back side of the wall. The gaps must be filled with drainstone.
- When retaining walls are constructed with batter, the radius on outside curves becomes smaller with each course due to the block setback. For proper construction, the radius of the bottom course must be larger than the minimum radius so upper courses will have sufficient room for construction.
- When retaining walls are constructed with a batter, the radius on inside curves becomes larger with each course due to the block setback.

OUTSIDE CURVE

INSIDE CURVE

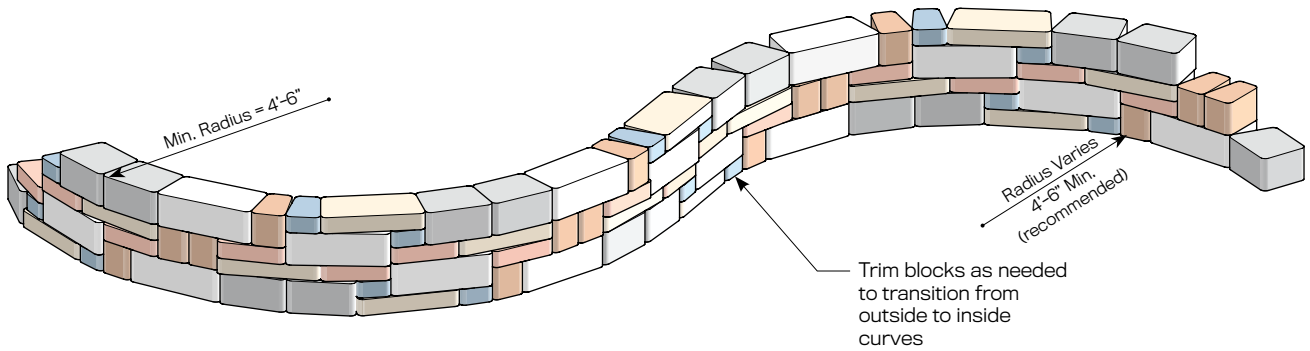

PLANTER / TREE RING

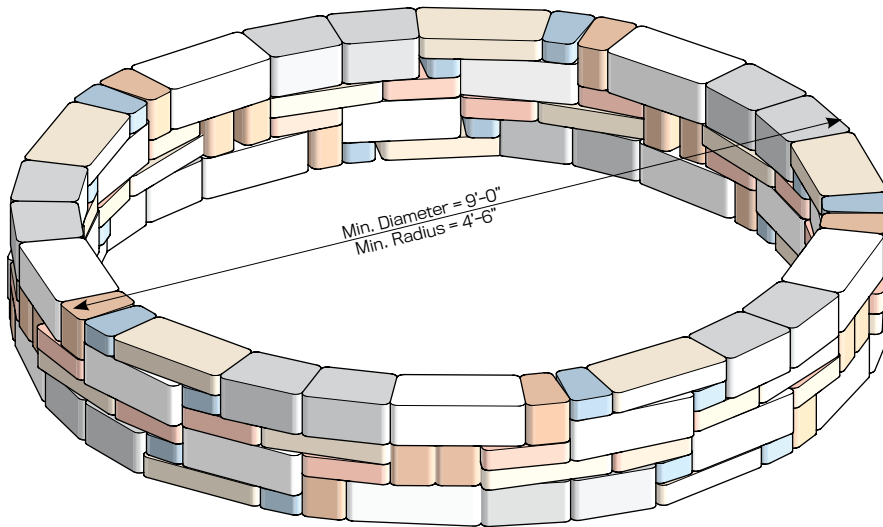

NOTE: CURVED FREESTANDING WALLS

Curved freestanding walls can also be built. Typically, the blocks have to be field adjusted to make the desired curve. Front and back faces will alternate and blocks should be trimmed as needed to provide a tight fit between blocks with no gaps on either side of the freestanding wall.

RETAINING WALL CORNERS

This page shows typical construction details for Belvedere® 90° corners.

- Some basic concepts are shown here for 90° corners. Plan to take some time to properly work corners into the larger retaining and freestanding wall patterns.
- Walls are shown without batter for clarity. Blocks in a retaining wall should be adjusted slightly in place and trimmed as needed to allow wall construction with proper batter.

OUTSIDE CORNER

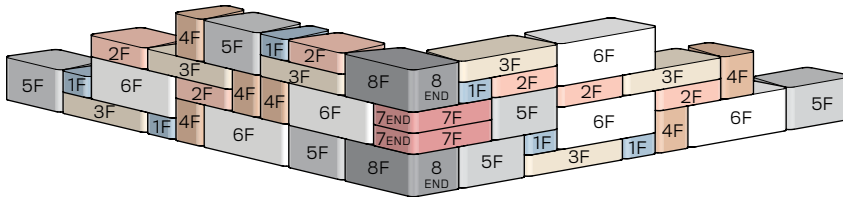

INSIDE CORNER

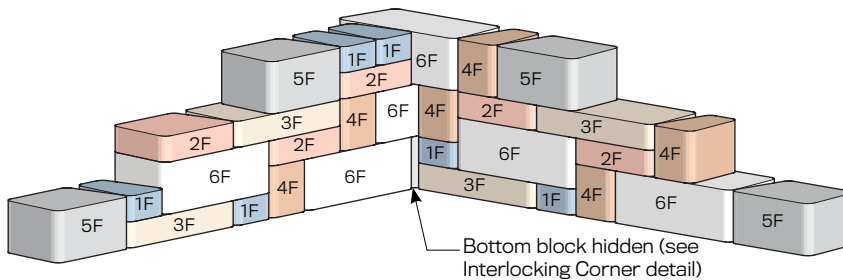

INTERLOCKING CORNER

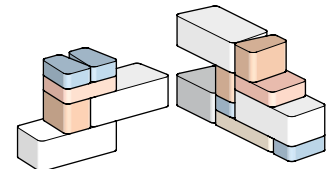

Place block in an overlapping, interlocking pattern at corner for added wall stability.

COLUMNS

Columns make nice ends to freestanding walls, formal stair openings, stand-alone monuments, and other areas to enhance your Belvedere® project. The basic steps of column construction are shown here. Feel free to expand on these ideas and bring your own creativity into creating a custom project.

Step 1

Place (4) 3" or 6" high corner blocks with the taper facing into the center of the column.

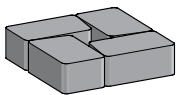

Step 2

Place the second row of (4) of the corner blocks with the taper facing into the center of the column. Typically if the first row is built with 6" corner blocks, the second row is built with 3" corner blocks.

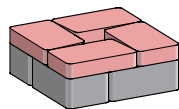

Step 3

Continue with subsequent rows to the desired column height. One pallet of corner blocks will make a 24" x 24" x 36" high column.

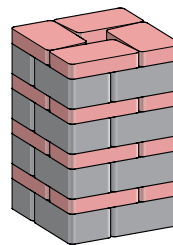

Step 4

Place a column cap to finish the column. The column cap can be cored as needed for installation of a light.

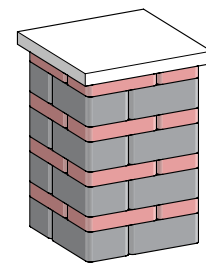

COLUMNS WITH FREESTANDING WALL

Freestanding walls with columns on each end can be constructed either with the columns flush with the wall, or blocks trimmed to interlock the end of the wall with the column.

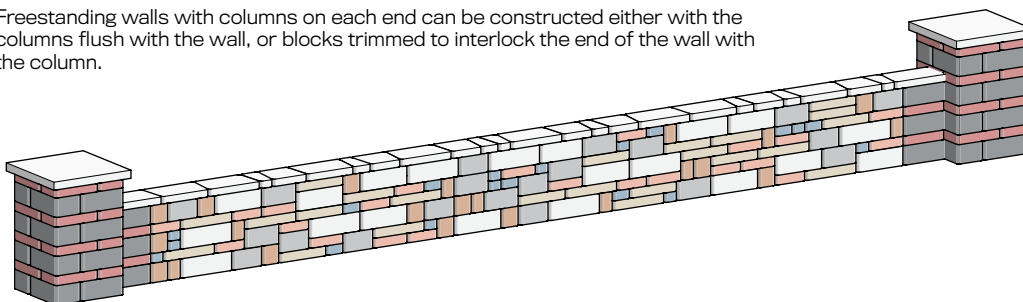

GENERAL NOTES FOR WALL SECTIONS

This page shows typical construction details for Belvedere® walls. These drawings are representative of major components required in wall construction. Specific details including geotextile reinforcement layers, drainage details, soil requirements, etc. shall be per engineered design for wall.

- These drawings are for preliminary reference only (not for final construction).
- Final designs for construction **must be prepared by a registered professional engineer** using the actual conditions of the proposed site and loads.
- Final wall design must address both internal and external drainage and shall be evaluated by the professional engineer who is responsible for the wall design.
- Block size and placement shown are for reference only, individual Belvedere® blocks will vary with installation pattern.

TYPICAL FREESTANDING WALL DETAIL

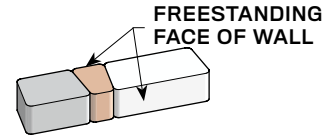
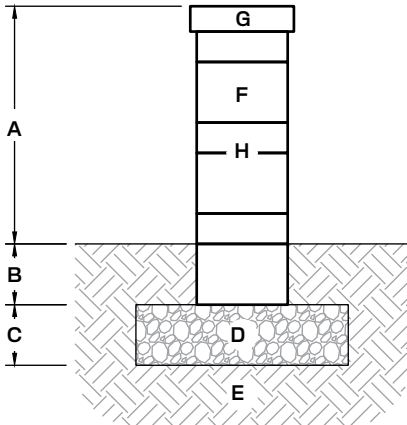

- A. Exposed height (max. 24")
- B. Bury depth (min. 6")
- C. Leveling pad depth (min. 6")
- D. Crushed stone leveling pad
- E. Foundation soil compacted to 95% max. dry density
- F. Wall blocks
- G. Coping block
- H. Concrete adhesive required between all blocks and caps

TYPICAL GRAVITY RETAINING WALL DETAIL

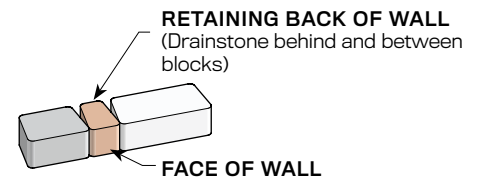
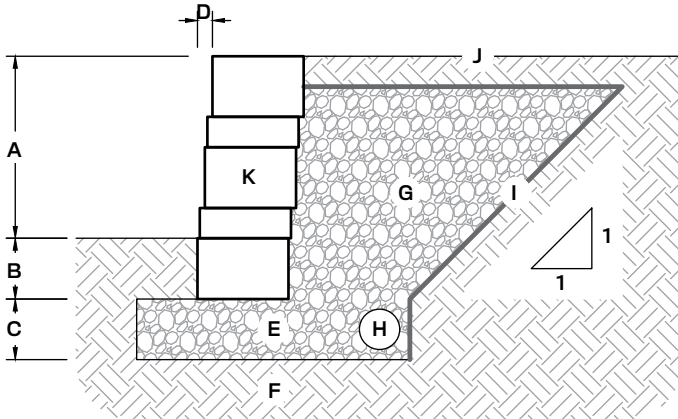

- A. Exposed height (varies)
- B. Bury depth (min. 6")
- C. Leveling pad depth (min. 6")
- D. 1/2" setback per 6" vertical (5°)
- E. Crushed stone leveling pad
- F. Foundation soil compacted to 95% max. dry density
- G. Drainstone (ASTM #57), min. 12", on 1:1 slope behind wall
- H. 4" corrugated perforated drain pipe
- I. Non-woven geotextile fabric
- J. Finish grade to drain away from the wall
- K. Wall blocks

TYPICAL REINFORCED RETAINING WALL DETAIL

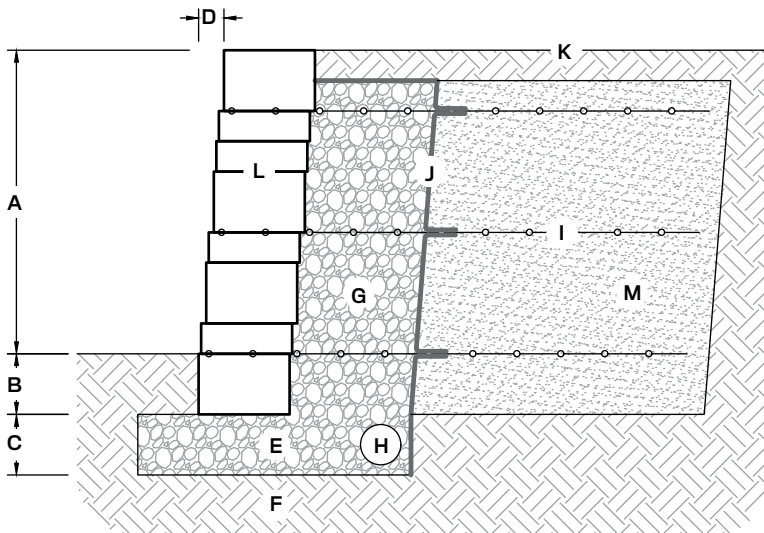

- A. Exposed height (varies by design)
- B. Bury depth (varies by design)
- C. Leveling pad depth (varies by design)
- D. 1/2" setback per 6" vertical (5°)
- E. Crushed stone leveling pad
- F. Foundation soil compacted to 95% max. dry density
- G. Drainstone (ASTM #57, min. 12" behind wall)
- H. 4" corrugated perforated drain pipe
- I. Geogrid (lengths and vertical placement per design)
- J. Non-woven geotextile fabric
- K. Finish grade to drain away from the wall
- L. Wall blocks
- M. Reinforced soil compacted to 95% max. dry density



HEARTWOOD

FEATURES

- Beautiful wood-grain texture on five sides allows each piece to be a wall unit or a corner unit
- More durable and much longer lasting than pressure-treated lumber
- Excellent for freestanding seat walls and garden retaining walls

MATERIAL WETCAST

Refer to our website for the most recent color offerings.



Learn More

WALL PALLET

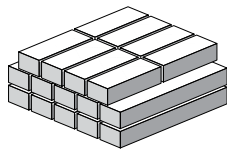

Weight: 2,450± lbs (inc. pallet)
 Coverage: 24.5 sq ft
 Layers Per Pallet: 3

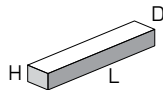

UNIT: 1

Dimensions: 42"L x 8"D x 6"H
 Weight: 175± lbs
 Units Per Pallet: 10

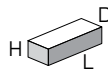

UNIT: 2

Dimensions: 21"L x 8"D x 6"H
 Weight: 88± lbs
 Units Per Pallet: 8

GENERAL NOTES FOR WALL SECTIONS

This page shows typical construction details for Heartwood walls. These drawings are representative of major components required in wall construction. Specific details including geotextile reinforcement layers, drainage details, soil requirements, etc. shall be per engineered design for wall.

- These drawings are for preliminary reference only (not for final construction).
- Final designs for construction must be prepared by a registered professional engineer using the actual conditions of the proposed site.
- Final wall design must address both internal and external drainage and shall be evaluated by the professional engineer who is responsible for the wall design.

TYPICAL FREESTANDING WALL DETAIL

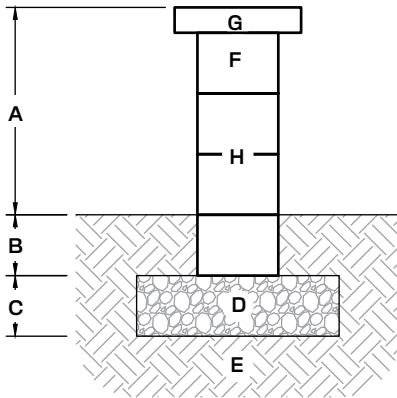

- A. Exposed height (varies, max. 24")
- B. Bury depth (min. 6")
- C. Leveling pad depth (min. 6")
- D. Crushed stone leveling pad
- E. Foundation soil compacted to 95% max. dry density
- F. Wall blocks
- G. Coping block
- H. Heavy Duty Construction Adhesive or One-Component, High Performance, Elastomeric Polyurethane Sealant required between all blocks and caps

TYPICAL GRAVITY RETAINING WALL DETAIL

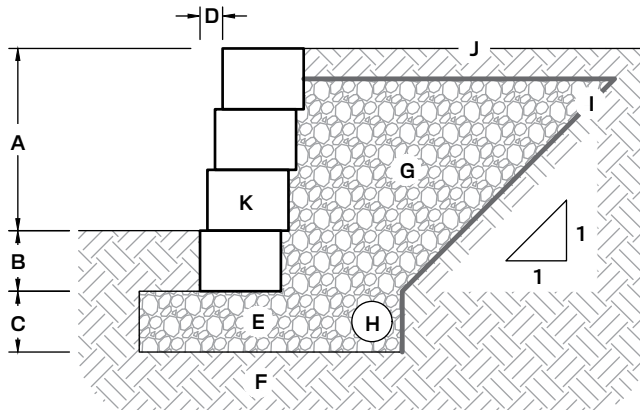

- A. Exposed height (varies by design), 2' max. height without reinforcement
- B. Bury depth (varies by design, min. 6")
- C. Leveling pad depth (varies by design, min. 6")
- D. 3/4" setback per 6" vertical (7°)
- E. Crushed stone leveling pad
- F. Foundation soil compacted to 95% max. dry density
- G. Drainstone (ASTM #57), min. 12", on 1:1 slope behind wall
- H. 4" corrugated perforated drain pipe
- I. Non-woven geotextile fabric
- J. Finish grade to drain away from the wall
- K. Wall blocks

TYPICAL REINFORCED RETAINING WALL DETAIL

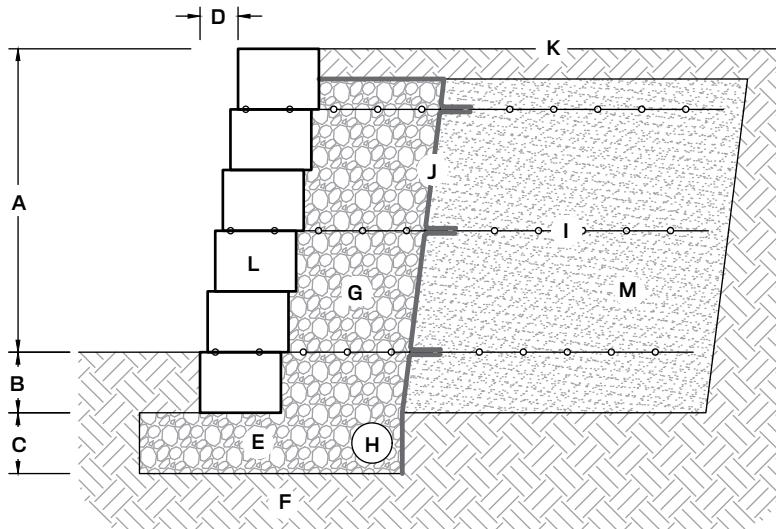

- A. Wall height above grade (varies by design)
- B. Wall buried beneath grade (varies by design, min. 6")
- C. Leveling pad depth (varies by design, min. 6")
- D. 3/4" setback per 6" vertical (7°)
- E. Crushed stone leveling pad
- F. Foundation soil compacted to 95% max. dry density
- G. Drainstone (ASTM #57, min. 12" behind wall)
- H. 4" corrugated perforated drain pipe
- I. Geogrid (lengths and vertical placement per design)
- J. Non-woven geotextile fabric
- K. Finish grade to drain away from the wall
- L. Wall blocks
- M. Reinforced soil compacted to 95% max. dry density



DIMENSIONAL

FEATURES

- Perfect for small garden and freestanding walls, custom bar and grill units, edging, columns and more
- Small and lightweight units for easy stacking
- Natural stone texture on four sides

STRAIGHT PALLET

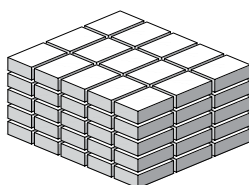

Weight:	2,100± lbs (inc. pallet)
Coverage (Retaining):	25 sq ft
Coverage (Freestanding):	25 sq ft
Layers Per Pallet:	5
Section:	sold by the piece

MATERIAL WETCAST

Refer to our website for the most recent color offerings.

Actual weight and volumes may vary. Weight shown is based on concrete.

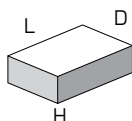

UNIT: STRAIGHT

Dimensions:	12"L x 8"D x 4"H
Weight:	28± lbs
Units Per Pallet:	75



Learn More

COLUMNS

Columns make wall ends to freestanding walls, formal stair openings, stand-alone monuments, and other areas to enhance your Dimensional project. The basic steps of column construction are shown here. Feel free to expand on these ideas and bring your own imagination into creating a custom project.

Step 1

Place (4) Dimensional Blocks.

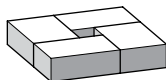

Step 2

Place a second row of (4) Dimensional Blocks.

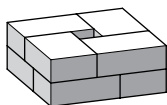

Step 3

Continue with subsequent rows to the desired column height. One pallet of corner blocks will create two 20" x 20" x 36" tall columns.

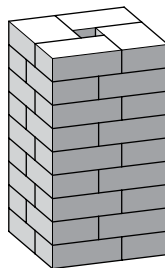

Step 4

Place a column cap to finish the column. The column cap can be cored as needed for installation of a light.

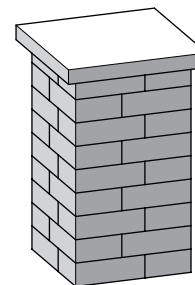

GENERAL NOTES FOR WALL SECTIONS

This page shows typical construction details for Dimensional walls. These drawings are representative of major components required in wall construction. Specific details including geotextile reinforcement layers, drainage details, soil requirements, etc. shall be per engineered design for wall.

- These drawings are for preliminary reference only (not for final construction).
- Final designs for construction **must be prepared by a registered professional engineer** using the actual conditions of the proposed site and loads.
- Final wall design must address both internal and external drainage and shall be evaluated by the professional engineer who is responsible for the wall design.

TYPICAL FREESTANDING WALL DETAIL

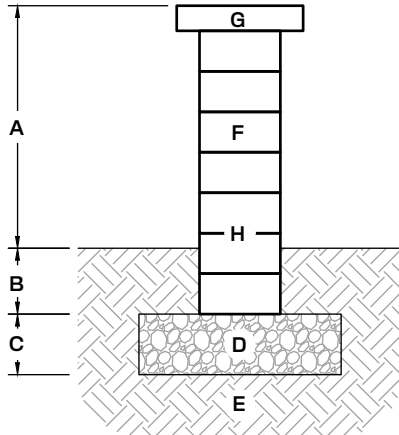

- A. Exposed height (varies, max. 24")
- B. Bury depth (min. 6")
- C. Leveling pad depth (min. 6")
- D. Crushed stone leveling pad
- E. Foundation soil compacted to 95% max. dry density
- F. Wall blocks
- G. Coping block
- H. Heavy Duty Construction Adhesive or One-Component, High Performance, Elastomeric Polyurethane Sealant required between all blocks and caps

TYPICAL GRAVITY RETAINING WALL DETAIL

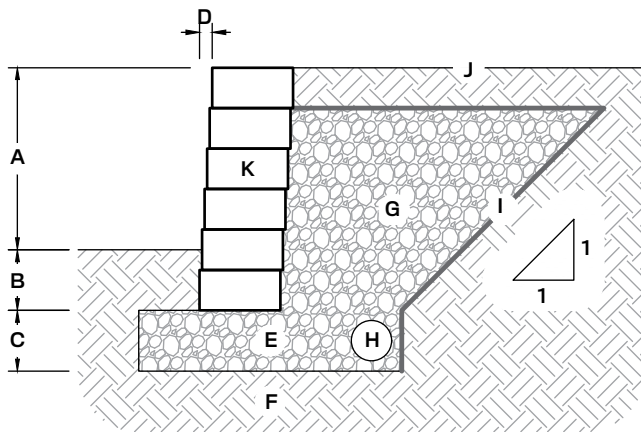

- A. Exposed height (varies by design), 2' max height without reinforcement
- B. Bury depth (varies by design, min. 6")
- C. Leveling pad depth (varies by design, min. 6")
- D. Recommended horizontal setback, 1/4" setback per 4" vertical (4° batter angle on wall)
- E. Crushed stone leveling pad
- F. Foundation soil compacted to 95% max. dry density
- G. Drainstone (ASTM #57), min. 12", on 1:1 slope behind wall
- H. 4" corrugated perforated drain pipe
- I. Non-woven geotextile fabric
- J. Finish grade to drain away from the wall
- K. Wall blocks

TYPICAL REINFORCED RETAINING WALL DETAIL

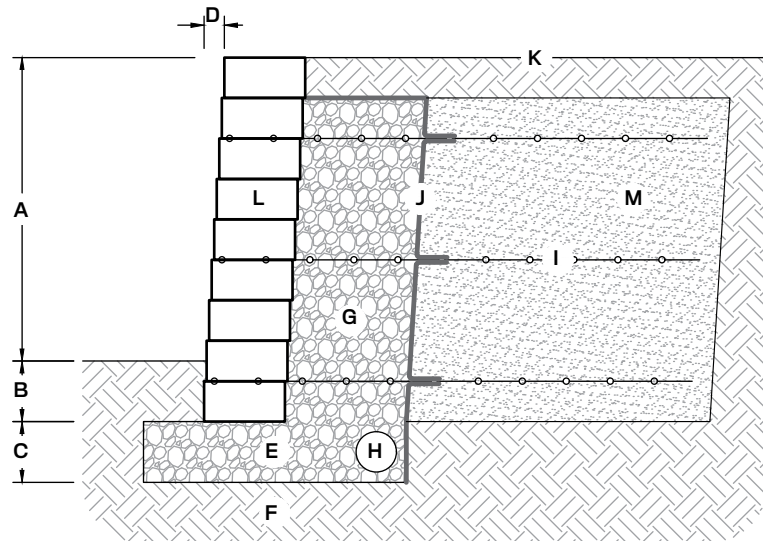

- A. Exposed height (varies by design)
- B. Bury depth (varies by design, min. 6")
- C. Leveling pad depth (varies by design, min. 6")
- D. Recommended horizontal setback, 1/4" setback per 4" vertical (4° batter angle on wall)
- E. Crushed stone leveling pad
- F. Foundation soil compacted to 95% max. dry density
- G. Drainstone (ASTM #57), min. 12" behind wall
- H. 4" corrugated perforated drain pipe
- I. Geogrid reinforcement (lengths and vertical placement per design)
- J. Non-woven geotextile fabric
- K. Finish grade to drain away from the wall
- L. Wall blocks
- M. Reinforced soil compacted to 95% max. dry density

SLABS & PAVERS

GENERAL INFORMATION
GAUGE SELECT
MID-CENTURY
MONTROSE
ARCADIA
TETRA
GRAND FLAGSTONE
DIMENSIONAL FLAGSTONE
NEW MISSION
SUPERIOR STEPPERS

Technical information for our natural stone products can be found on our website.

For your convenience, please scan our QR code to download our marble and travertine French pattern paver layout sheet.



INSTALLATION GUIDE

BASIC SLAB INSTALLATION NOTES FOR:

- Gauge Select
- Mid-Century
- Montrose
- Arcadia
- Tetra

Refer to product pages for specific information and details pertaining to individual products.

SAFETY

Make safety your top priority when installing our paving products. Before starting your project, be sure to address the following points:

Contact your local utility marking service prior to making any excavation. Be sure to follow all governmental safety regulations.

Always wear the appropriate personal protective equipment (PPE) including gloves, steel toed boots, safety glasses, hearing protection, respiratory protection, and any other needed safety gear.

Gauge Select, Mid-Century, Montrose, Arcadia and Tetra slabs are heavy. Utilize mechanical installation when possible. Follow proper lifting techniques to avoid back injury. Also, use two people to set larger pieces.

PROJECT PLANNING

The first step in installing our paving products is to plan your project. Slab layout and placement is important to insure a functional and good looking installation. Remember, Gauge Select, Mid-Century, Montrose, Arcadia and Tetra products are suitable for pedestrian loading only (patios, walkways, etc.) and will not support the load of a vehicle.

EXCAVATION AND BASE PREPARATION

Once you are ready to start construction, you will need to lay out the project area. Mark out the area of the installation with marking paint. Mark a second line 12" (305 mm) outside of the first line that indicates the area to be excavated. This over-excavation will allow for proper base installation.

Excavate to the required depth and grade for the installation of the specific paving product you are installing (see cross sections for minimum recommended excavation depths). Remove all topsoil, organic, or otherwise unsuitable soil and replace with compacted granular soil. Once the excavation depth has been established, compact the sub-grade well using a vibratory plate compactor. At this point, HIGH FORMAT® recommends laying a woven geotextile down before applying any granular base materials.

FOR THE MOST NATURAL APPEARANCE, MIX AND INSTALL PRODUCTS FROM MULTIPLE PALLETS SIMULTANEOUSLY. THIS WILL CREATE A MORE BLENDED, NATURAL LOOK.

PLACE THE COMPACTED GRAVEL BASE

- Fill the compacted sub-base with a minimum 4-inches of dense graded road aggregate. Compact with a vibratory plate compactor.
- Install low-profile paver edging around the perimeter of the patio. Fill with 1-inch of clean, washed bedding sand. Screed flat using screed rails and a screed board. Remember to maintain a $\pm 1\%$ pitch for proper surface water management.

Use of aggregates other than sand is not recommended for the bedding layer. Coarse aggregates can create point-loads beneath large-surface slabs, and may damage the finished patio.

SLAB INSTALLATION

Begin by laying the individual pavers on screeded bedding material according to the installation pattern or detailed project plan.

- When the project requires more than one pallet of slabs, pull slabs from multiple pallets simultaneously. This will ensure the best blending of color on the project.
- Because Gauge Select, Mid-Century, Montrose, Arcadia and Tetra Slabs are so large, it may be necessary to step on the base during installation. To avoid disturbing the bedding sand, place a mason's kneeler board where you need to step on the base. This will distribute your weight more evenly.
- If any slabs require trimming, place them on a flat, evenly supported surface. Use the cut-off saw to score the surface of the slab $\pm 1/4$ -inch across entire length of the cut before plunging through the slab. This will reduce the chance of slabs fracturing outside the score-line. Joints can consist of polymeric sand, decorative aggregate, turf, and bricks or pavers. Be creative!

Do not use vibratory or roller compaction on the surface of Gauge Select, Mid-Century, Montrose, Arcadia and Tetra Slabs. It is not necessary and may point-load the slab, causing permanent damage.

GENERAL INFORMATION

BASIC SLAB & PAVER INSTALLATION NOTES FOR:

- Grand Flagstone
- Dimensional Flagstone
- New Mission
- Superior Steppers

Refer to product pages for specific information and details pertaining to individual products.

Thank you for your interest in installing our paving products. You will find that these products truly combine the look of natural stone with the efficiency and consistency of concrete pavers.

SAFETY

Make safety your top priority when installing our paving products. Before starting your project, be sure to address the following points:

Contact your local utility marking service prior to making any excavation. Be sure to follow all governmental safety regulations.

Always wear the appropriate personal protective equipment (PPE) including gloves, steel toed boots, safety glasses, hearing protection, respiratory protection, and any other needed safety gear.

Flagstone slabs are heavy. Utilize mechanical installation when possible. Follow proper lifting techniques to avoid back injury. Also, use two people to set larger pieces.

PROJECT PLANNING

The first step in installing our paving products is to plan your project. Paver layout and placement is important to insure a functional and good looking installation. Remember, Flagstone products are suitable for pedestrian loading only (patios, walkways, etc.) and will not support the load of a vehicle. New Mission Pavers are suitable for vehicular loading.

EXCAVATION AND BASE PREPARATION

Once you are ready to start construction, you will need to lay out the project area. Mark out the area of the installation with marking paint. Mark a second line 12" (305 mm) outside of the first line that indicates the area to be excavated. This over-excavation will allow for proper base installation.

Excavate to the required depth and grade for the installation of the specific paving product you are installing (see cross sections for minimum recommended excavation depths). Once the excavation depth has been established, compact the sub-grade well using a vibratory plate compactor. At this point, HIGH FORMAT® recommends laying a woven geotextile down before applying any granular base materials.

**FOR THE MOST NATURAL
APPEARANCE, MIX AND
INSTALL PRODUCTS
FROM MULTIPLE PALLETS
SIMULTANEOUSLY. THIS WILL
CREATE A MORE BLENDED,
NATURAL LOOK.**

PLACE THE COMPACTED GRAVEL BASE

For standard paver and flagstone installations, begin by spreading half of granular base material in the excavation. (Note: Lifts should not exceed 6" (150 mm) in thickness.) Compact this first lift to 98% standard proctor using a vibratory plate compactor and adding water as needed. Add the second lift of granular material and compact in the same manner as the first.

KEY POINT: When installing granular base materials, be sure to consider proper grades to prevent water from standing on the surface and make sure water is directed away from building structures.

PAVER INSTALLATION

Bedding material requirements and paver installation vary by product type. Please see the following product specific installation instructions and tips for more details on paver installation.

GENERAL INFORMATION

ADDITIONAL INSTALLATION NOTES FOR:

- New Mission

Refer to product pages for specific information and details pertaining to individual products.

INSTALLATION NOTES

The following guidelines are based on minimum recommendations from the ICPI (Interlocking Concrete Pavement Institute). For an in-depth overview of the design and installation of interlocking concrete pavements and permeable pavements, please visit their website at icpi.org. Paver cross-sections and details shown are based on pedestrian or residential drive loadings with normal site conditions. Foundation, gravel base, and drainage details will need to be addressed if poor soil conditions or commercial or industrial vehicular loadings will be present.

EDGE RESTRAINT

Before installing pavers or bedding material, ensure proper paver edge restraint has been installed. Edge restraint should consist of a precast or cast-in-place concrete curb. For pedestrian loads or residential drives, plastic or metal edging strips fastened to the compacted base below with metal spikes are an acceptable alternative.

BEDDING MATERIAL

For standard paver installation, apply bedding sand at a maximum thickness of 1" (25mm) on top of the compacted granular base. Level bedding sand evenly by using a screed board along the top of the screed rails.

PAVER INSTALLATION

Begin by laying the individual pavers on screeded bedding material according to your detailed project plan.

- Push pavers together so the outermost edges butt tight, and cut units as needed to finish edges.
- To ensure proper color distribution, mix layers from several bundles at one time.
- Once installed, set pavers in bedding material by compacting with a plate compactor equipped with a urethane pad (to avoid damage to the paver surface). Compaction should proceed in overlapping rows such that each area is crossed at least twice by the compactor in two perpendicular directions. Note that pavements should be filled and compacted to within six feet of the laying surface at the end of each work day.
- KEY POINT: Pavers will settle slightly (1/4" - 3/8") during compaction. Final grade of base and bedding material should be adjusted to account for this settlement. Take special care where pavers abut existing site features such as other pavements.

CAUTION: A urethane pad must be used with the plate compactor to avoid damage to pavers.

JOINT SAND

Fill all joints with jointing sand for standard paver installations or appropriate aggregate for permeable installations. Sweep joint filler material into the joints between pavers until the joints are completely filled. After the joints are filled, carefully sweep pavers clean before compacting. Loose joint material could damage the surface of the pavers during compaction. Top off joints if joint material settles during compaction and re-compact if necessary.

OTHER CONSIDERATIONS

When snowplowing New Mission Pavers, a poly cutting edge must be used to avoid marking the surface of the pavers.

Do not use de-icing salts on New Mission Pavers. Use of de-icing salts can damage the surface and will void the product warranty.

GAUGE SELECT

FEATURES

- Massive dimensions and lightweight for rapid installation
- Made with TEKTRAMAT® for unsurpassed durability and a salt-proof surface, with four times the compressive strength and twice the flexural strength of normal concrete
- Authentic stone surfaces accurately replicate natural cleft flagstone (your feet can't tell the difference)

MATERIAL TEKTRAMAT®

Refer to our website for the most recent color offerings.



[Learn More](#)

PALLET

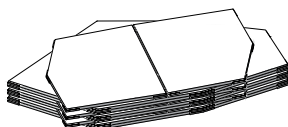

Dimensions: 66"L x 48"W x 18"H
 Weight: 1,500 lbs (inc. pallet)
 Coverage: 105 sq ft

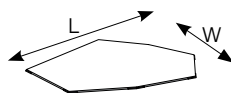

UNIT: 1

Dimensions: 60"L x 42"W x 1"H
 Weight: 155 lbs
 Coverage: 12.25 sq ft
 Units Per Pallet: 6

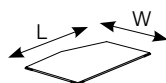

UNIT: 2

Dimensions: 36"L x 23"W x 1"H
 Weight: 64 lbs
 Coverage: 5.25 sq ft
 Units Per Pallet: 6

CONNECTING LABELED LUGS ALONG EDGES

STEP 1

Pair Unit 1 with Unit 2 along the longest edge.

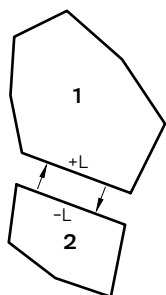

STEP 2

Rotate additional stones. Align appropriate "+" and "-" sides.

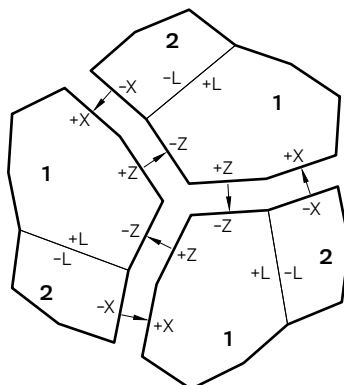

STEP 3

Continue to lay stones until the patio is complete.

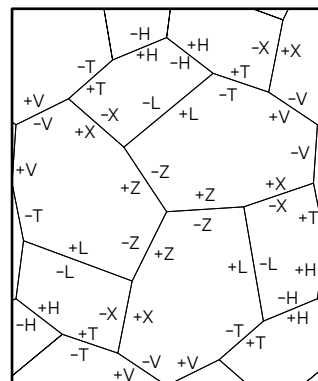

GAUGE SELECT

PATTERNS - PATIO

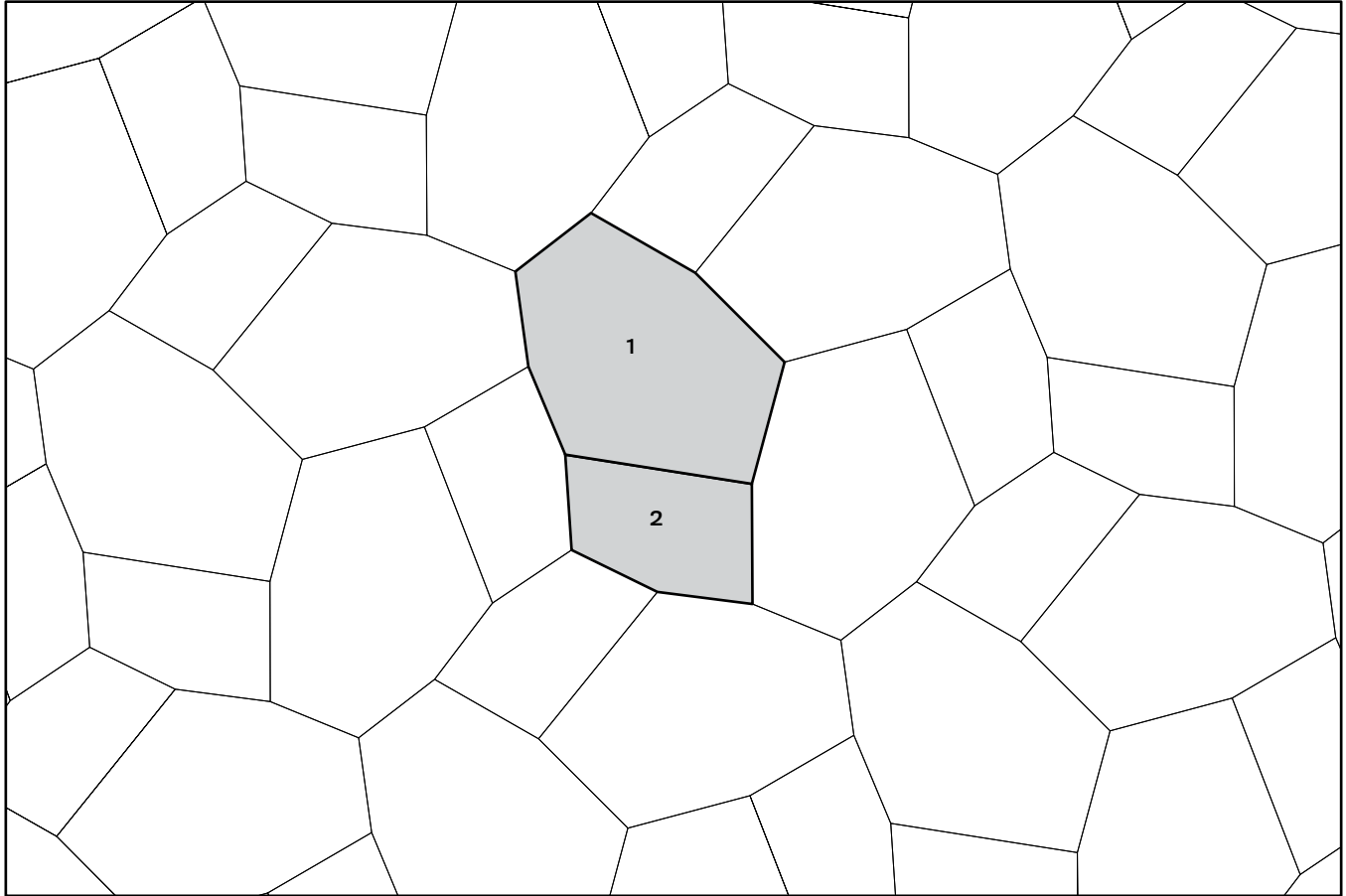

WALKWAY

It is possible to create walkways from Gauge Select with no waste.

STEP 1

Layout six pieces of Gauge Select (3 large and 3 small) as shown.

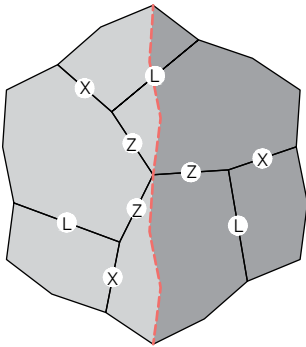

STEP 2

Trim an irregular line from point to point as shown. Be sure to score the entire line before plunge cutting to ensure a desired cut-line.

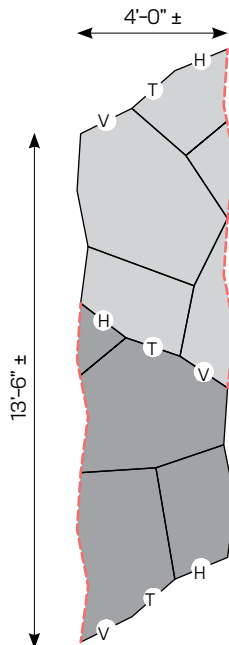

FOR A 4-FT WIDE PATHWAY STEP 3

Layout the trimmed sections of Gauge Select as shown. This layout is repeatable to achieve any desired length.

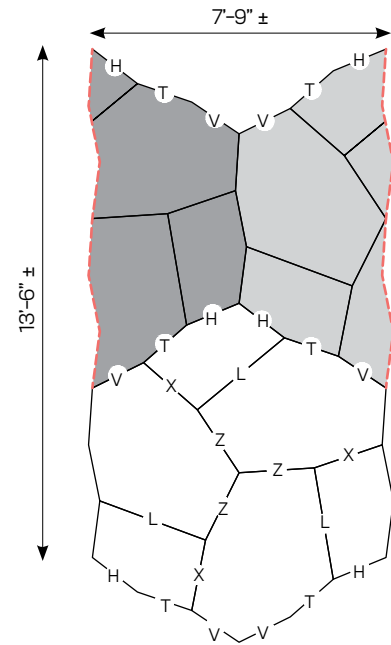

FOR AN 8-FT WIDE PATHWAY STEP 3

Layout an additional six untrimmed pieces of Gauge Select in the same orientation as the pieces that were trimmed.

STEP 4

Layout the trimmed sections of Gauge Select as shown. This layout is repeatable to achieve any desired length.

GENERAL NOTES FOR DETAILS

This page shows typical details for Gauge Select Slabs.

- This drawing is for preliminary reference only (not for final construction).
- Final designs for construction must be prepared by a registered professional engineer using the actual conditions of the proposed site and loads.
- Block size and placement shown are for reference only, individual blocks vary with installation pattern.
- Section shown is the minimum recommendation for pedestrian loading. Projects with heavier traffic or sites with poor soil conditions may require thicker gravel base, concrete curb edge restraint, and/or sand subbase.
- Provide adequate surface drainage to prevent ponded water.

Not suitable for vehicular traffic.

TYPICAL RESIDENTIAL INSTALLATION

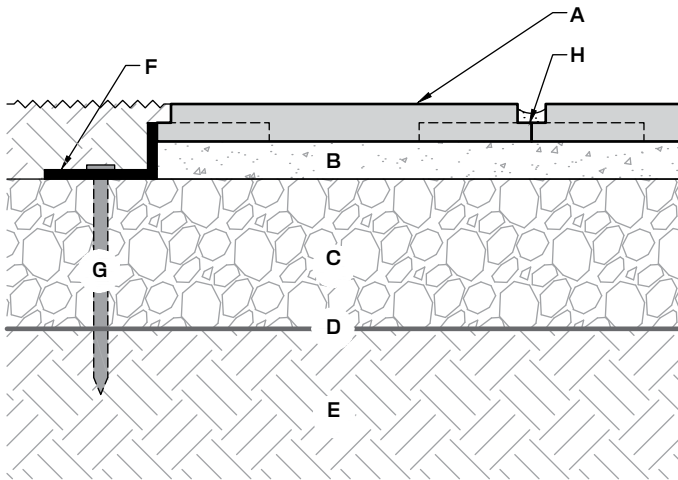

- A. Gauge Select Slab, 1" (25mm) thick
- B. Bedding sand (ASTM C33) min. 1" (25mm)
- C. Dense graded base, min. 4" (100mm), compacted
- D. Woven geotextile fabric (recommended)
- E. Compacted subgrade soil
- F. Low profile paver edge restraint
- G. Steel spike
- H. Joint sand (ASTM C144)

TYPICAL WET-SET INSTALLATION

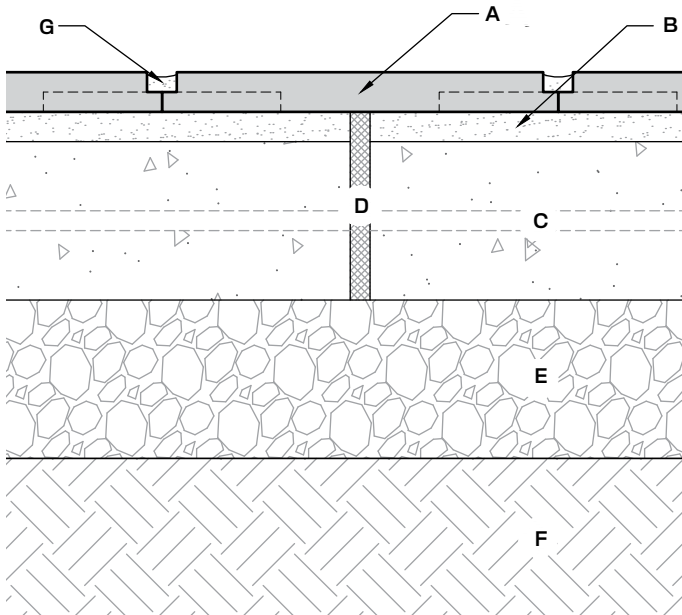

- A. Gauge Select Slab, 1" (25mm) thick
- B. Latex mortar, min. 3/4" (20mm)
- C. Reinforced concrete slab, min. 4" (100mm)
- D. Expansion joint, 1/2" (13mm)
- E. Dense graded base, min. 4" (100mm) compacted
- F. Compacted subgrade soil
- G. Latex mortar joint



MID-CENTURY

FEATURES

- Massive dimensions and lightweight for rapid installation
- Made with TEKTRAMAT® for unsurpassed durability and a salt-proof surface, with four times the compressive strength and twice the flexural strength of normal concrete
- Stylish modern aesthetic, featuring clean lines and thermalled stone textures

MATERIAL TEKTRAMAT®

Refer to our website for the most recent color offerings.



Learn More

PALLET

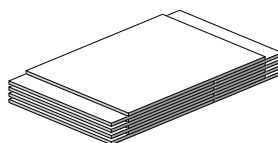

Dimensions: 66"L x 48"W x 18"H
 Weight: 1,500 lbs (inc. pallet)
 Coverage: 108 sq ft

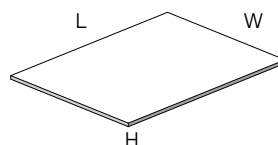

UNIT: 4 X 3
 Dimensions: 48"L x 36"W x 1"H
 Weight: 160 lbs
 Coverage: 12 sq ft
 Units Per Pallet: 4

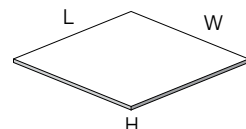

UNIT: 3 X 3
 Dimensions: 36"L x 36"W x 1"H
 Weight: 120 lbs
 Coverage: 9 sq ft
 Units Per Pallet: 4

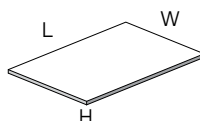

UNIT: 3 X 2
 Dimensions: 36"L x 24"W x 1"H
 Weight: 80 lbs
 Coverage: 6 sq ft
 Units Per Pallet: 4

MID-CENTURY

PATTERN

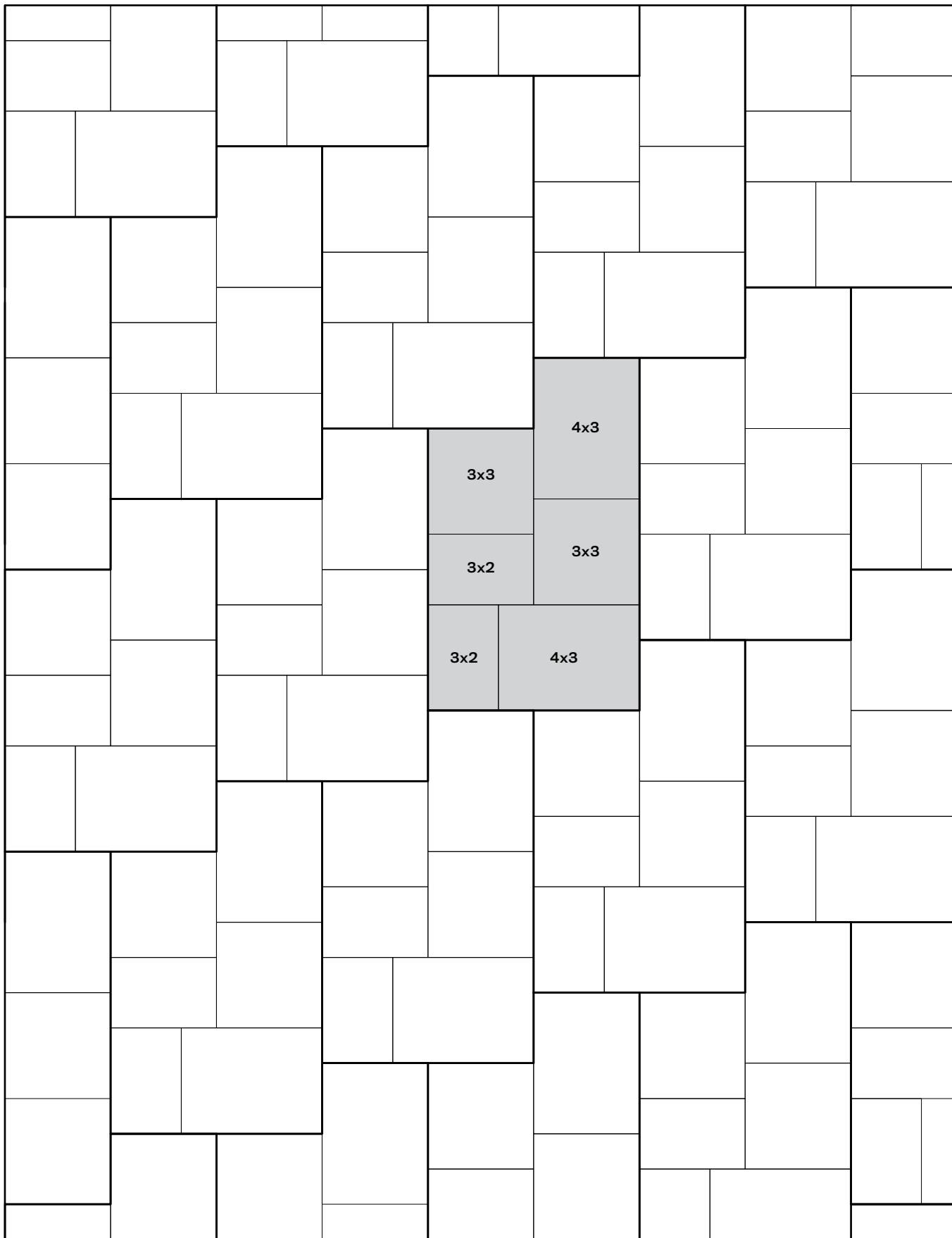

GENERAL NOTES FOR DETAILS

This page shows typical details for Mid-Century Slabs.

- This drawing is for preliminary reference only (not for final construction).
- Final designs for construction must be prepared by a registered professional engineer using the actual conditions of the proposed site and loads.
- Block size and placement shown are for reference only, individual blocks vary with installation pattern.
- Section shown is the minimum recommendation for pedestrian loading. Projects with heavier traffic or sites with poor soil conditions may require thicker gravel base, concrete curb edge restraint, and/or sand subbase.
- Provide adequate surface drainage to prevent ponded water.

Not suitable for vehicular traffic.

TYPICAL RESIDENTIAL INSTALLATION

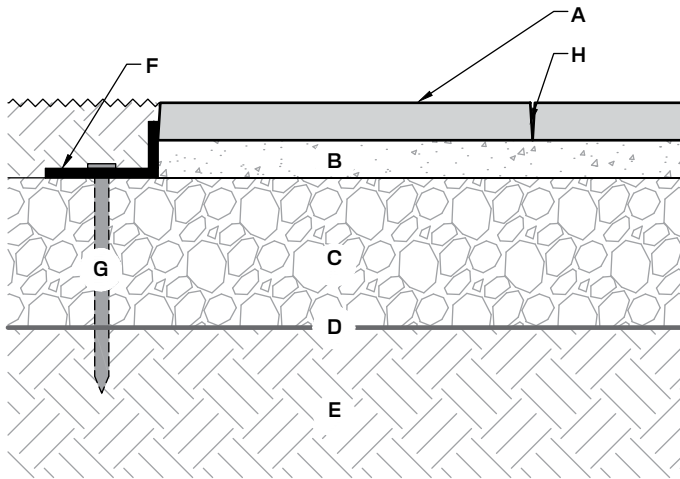

- A. Mid-Century Slab, 1" (25mm) thick
- B. Bedding sand (ASTM C33) min. 1" (25mm)
- C. Dense graded base, min. 4" (100mm), compacted
- D. Woven geotextile fabric (recommended)
- E. Compacted subgrade soil
- F. Low profile paver edge restraint
- G. Steel spike
- H. Joint sand (ASTM C144)

TYPICAL WET-SET INSTALLATION

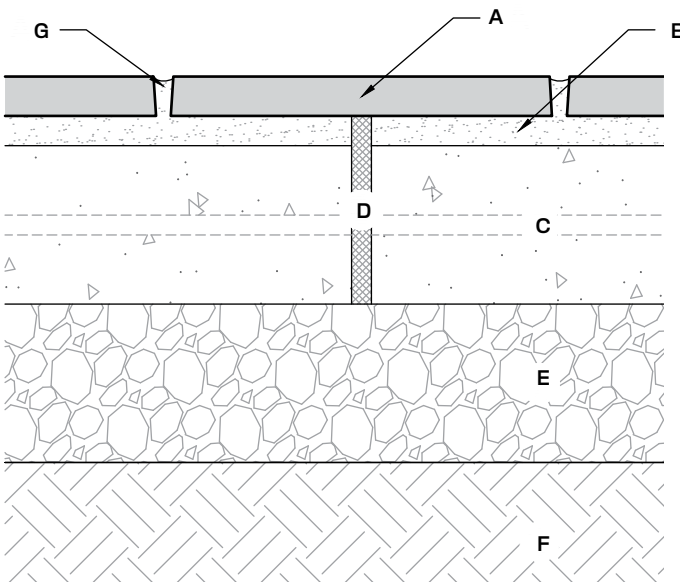

- A. Mid-Century Slab, 1" (25mm) thick
- B. Latex mortar, min. 3/4" (20mm)
- C. Reinforced concrete slab, min. 4" (100mm)
- D. Expansion joint, 1/2" (13mm)
- E. Dense graded base, min. 4" (100mm) compacted
- F. Compacted subgrade soil
- G. Latex mortar joint, 1/2" (13mm) recommended



MONTROSE

FEATURES

- Massive dimensions and lightweight for rapid installation
- Made with TEKTRAMAT® for unsurpassed durability and a salt-proof surface, with four times the compressive strength and twice the flexural strength of normal concrete
- Stylish modern aesthetic, featuring clean lines and thermalled stone textures

MATERIAL

TEKTRAMAT®

Refer to our website for the most recent color offerings.



Learn More

PALLET

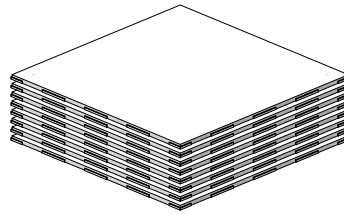

Dimensions: 66"L x 48"W x 18"H
 Weight: 1,300 lbs (inc. pallet)
 Coverage: 98 sq ft
 Layers Per Pallet: 8

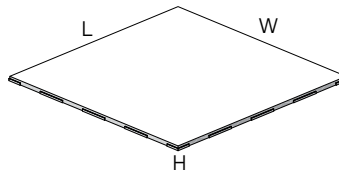

UNIT

Dimensions: 42"L x 42"W x 1"H
 Weight: 150 lbs
 Coverage: 12.25 sq ft
 Units Per Pallet: 8

PATTERNS

STACK BOND

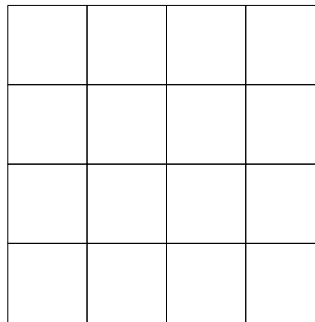

STACK BOND (4" JOINT)

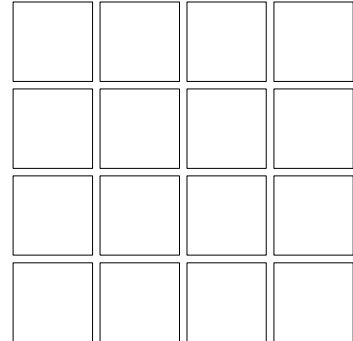

RUNNING BOND

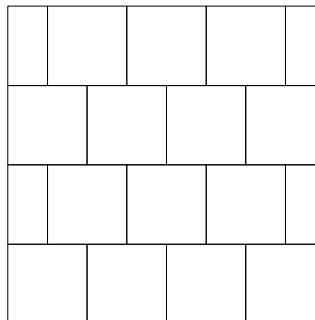

RUNNING BOND (4" JOINT)

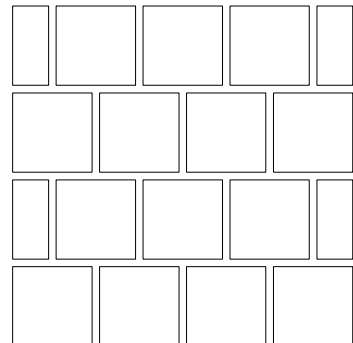

GENERAL NOTES FOR TYPICAL DETAILS

This page shows typical details for Montrose Slabs.

- This drawing is for preliminary reference only (not for final construction).
- Final designs for construction must be prepared by a registered professional engineer using the actual conditions of the proposed site and loads.
- Block size and placement shown are for reference only, individual blocks vary with installation pattern.
- Section shown is the minimum recommendation for pedestrian loading. Projects with heavier traffic or sites with poor soil conditions may require thicker gravel base, concrete curb edge restraint, and/or sand subbase.
- Provide adequate surface drainage to prevent ponded water.

Not suitable for vehicular traffic.

TYPICAL RESIDENTIAL INSTALLATION

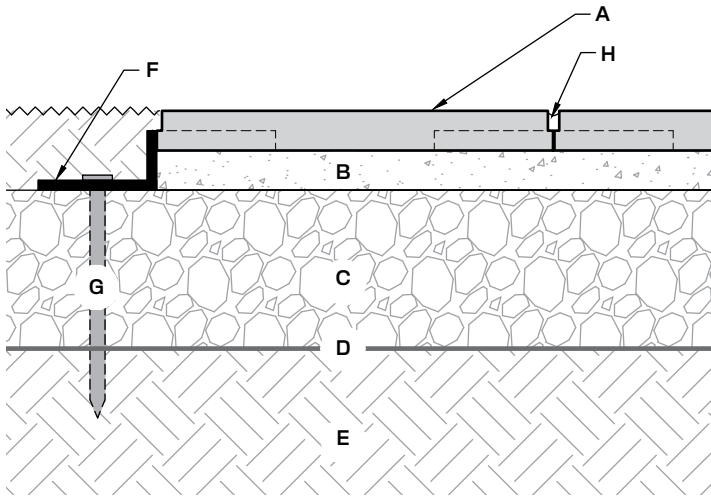

- A. Montrose Slab, 1" (25mm) thick
- B. Bedding sand (ASTM C33) min. 1" (25mm)
- C. Dense graded base, min. 4" (100mm), compacted
- D. Woven geotextile fabric (recommended)
- E. Compacted subgrade soil
- F. Low profile paver edge restraint
- G. Steel spike
- H. Joint sand (ASTM C144)

TYPICAL WET-SET INSTALLATION

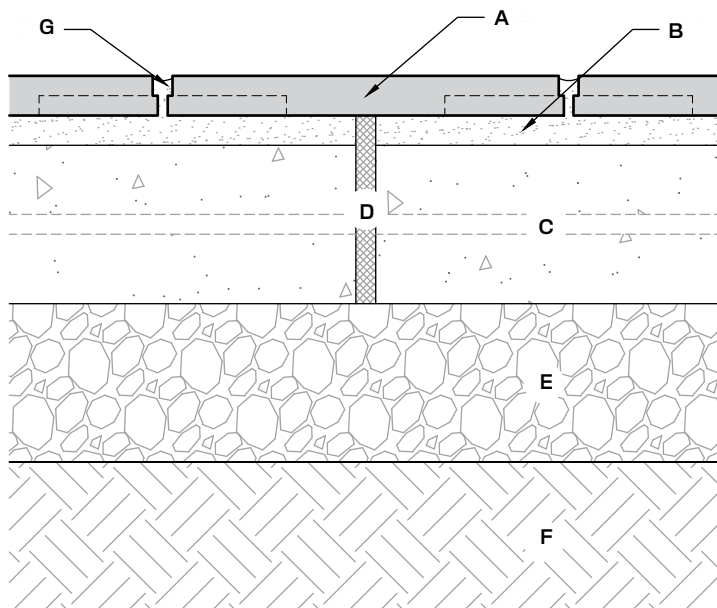

- A. Montrose Slab, 1" (25mm) thick
- B. Latex mortar, min. 3/4" (20mm)
- C. Reinforced concrete slab, min. 4" (100mm)
- D. Expansion joint, 1/2" (13mm)
- E. Dense graded base, min. 4" (100mm) compacted
- F. Compacted subgrade soil
- G. Latex mortar joint, 1/2" (13mm) recommended



ARCADIA

FEATURES

- Large format thermal finish slabs with modern styling and salt-proof surface
- Made with Tektramat® for unsurpassed durability, with four times the compressive strength and twice the flexural strength of normal concrete
- Generous size and light weight results in rapid installation

MATERIAL

TEKTRAMAT®

Refer to our website for the most recent color offerings.



Learn More

PALLET

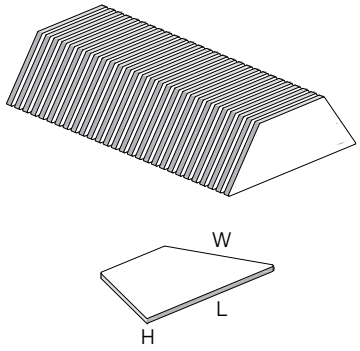

Dimensions: 56"L x 30"W x 22"H
 Weight: 1,325± lbs (inc. pallet)
 Coverage: 81.8 sq ft

UNIT

Dimensions: 36"L x 15.5"W x 1.25"H
 Weight: 44 lbs
 Coverage: 2.92 sq ft
 Units Per Pallet: 28

ARCADIA

PATTERNS

1-COLOR PATTERNS

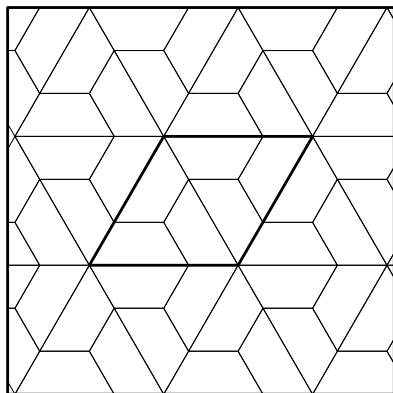
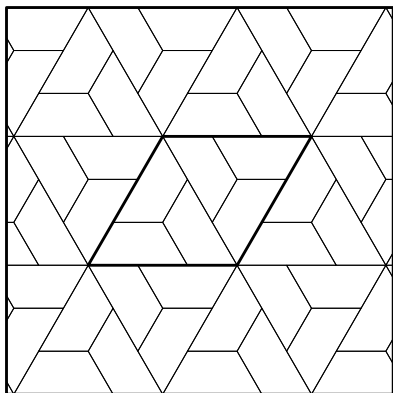
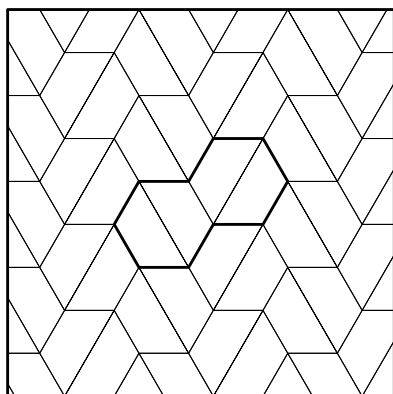
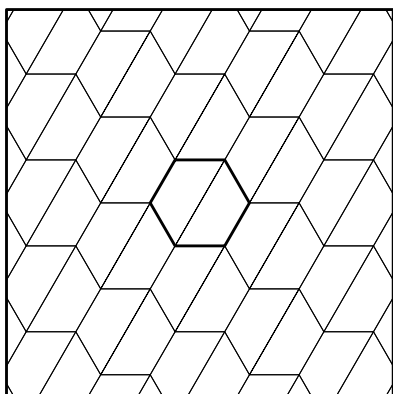

2-COLOR PATTERNS

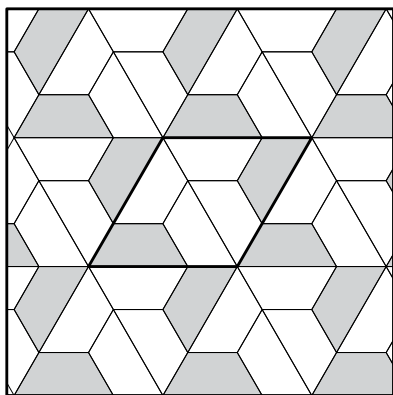
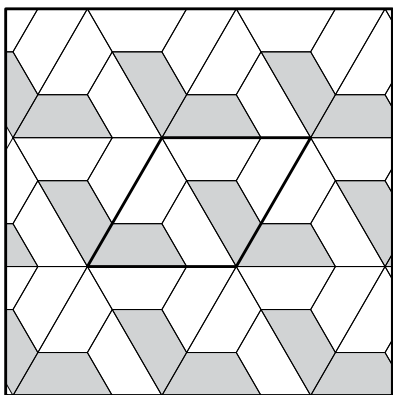
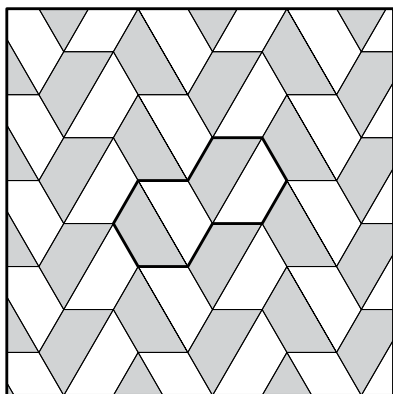
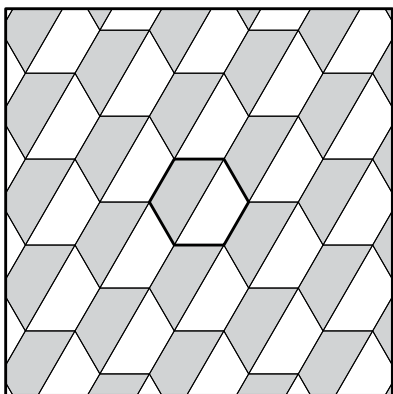

GENERAL NOTES FOR DETAILS

This page shows typical details for Arcadia Slabs.

- This drawing is for preliminary reference only (not for final construction).
- Final designs for construction must be prepared by a registered professional engineer using the actual conditions of the proposed site and loads.
- Block size and placement shown are for reference only, individual blocks vary with installation pattern.
- Section shown is the minimum recommendation for pedestrian loading. Projects with heavier traffic or sites with poor soil conditions may require thicker gravel base, concrete curb edge restraint, and/or sand subbase.
- Provide adequate surface drainage to prevent ponded water.

Not suitable for vehicular traffic.

TYPICAL RESIDENTIAL INSTALLATION

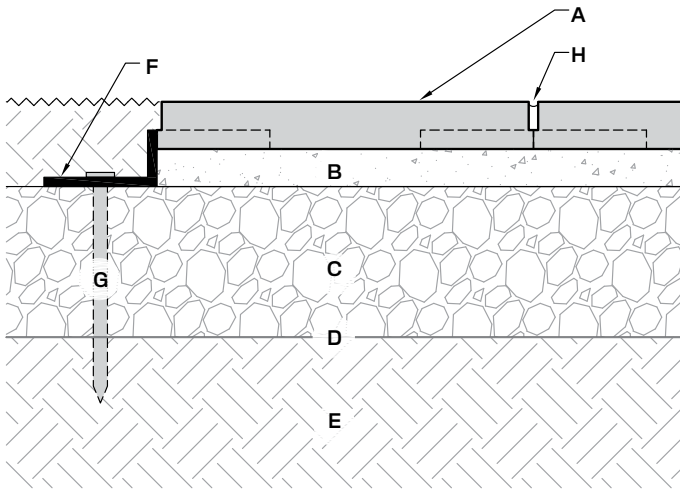

- A. Arcadia Slab, 1.25" (32mm) thick
- B. Bedding sand (ASTM C33) min. 1" (25mm)
- C. Dense graded base, min. 4" (100mm), compacted
- D. Woven geotextile fabric (recommended)
- E. Compacted subgrade soil
- F. Low profile paver edge restraint
- G. Steel spike
- H. Joint sand (ASTM C144)

TYPICAL WET-SET INSTALLATION

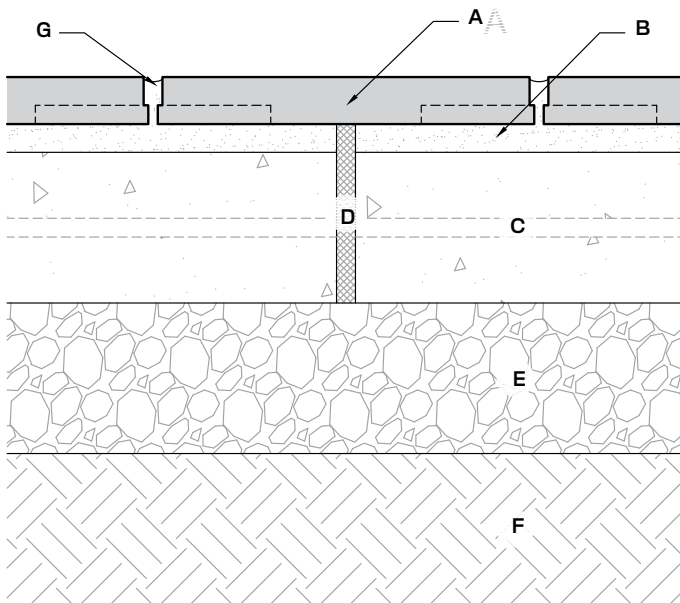

- A. Arcadia Slab, 1.25" (32mm) thick
- B. Latex mortar, min. 3/4" (20mm)
- C. Reinforced concrete slab, min. 4" (100mm)
- D. Expansion joint, 1/2" (13mm)
- E. Dense graded base, min. 4" (100mm) compacted
- F. Compacted subgrade soil
- G. Latex mortar joint, 1/2" (13mm) recommended



TETRA

FEATURES

- Large format landscape slabs with a salt-proof surface, and the option of Thermal or Natural Cleft texture
- Made with TEKTRAMAT® for unsurpassed durability, with four times the compressive strength and twice the flexural strength of normal concrete
- Generous size and light weight results in rapid installation

MATERIAL TEKTRAMAT®

Refer to our website for the most recent color offerings.



Learn More

PALLET

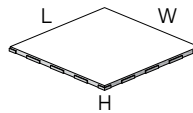
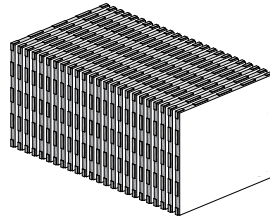

Dimensions: 56"L x 30"W x 36"H
 Weight: 2,350 lbs (inc. pallet)
 Coverage: 150 sq ft

UNIT

Dimensions: 30"L x 30"W x 1.25"H
 Weight: 95 lbs
 Coverage: 6.25 sqft
 Units Per Pallet: 24

PATTERNS

STACK BOND

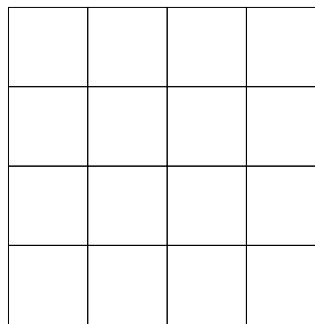

STACK BOND (4" JOINT)

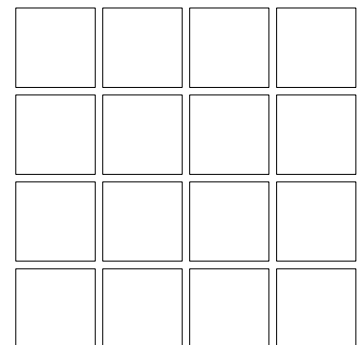

RUNNING BOND

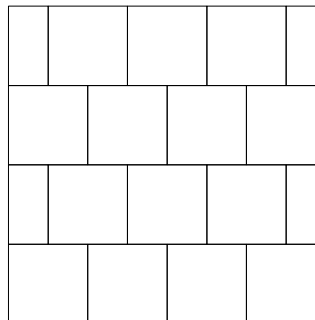

RUNNING BOND (4" JOINT)

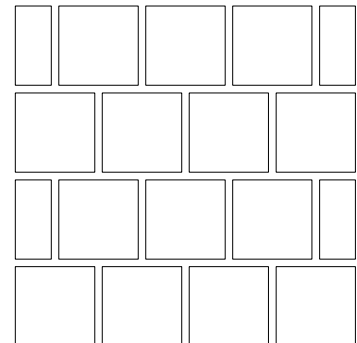

GENERAL NOTES FOR DETAILS

This page shows typical details for Tetra Slabs.

- This drawing is for preliminary reference only (not for final construction).
- Final designs for construction must be prepared by a registered professional engineer using the actual conditions of the proposed site and loads.
- Block size and placement shown are for reference only, individual blocks vary with installation pattern.
- Section shown is the minimum recommendation for pedestrian loading. Projects with heavier traffic or sites with poor soil conditions may require thicker gravel base, concrete curb edge restraint, and/or sand subbase.
- Provide adequate surface drainage to prevent ponded water.

Not suitable for vehicular traffic.

TYPICAL RESIDENTIAL INSTALLATION

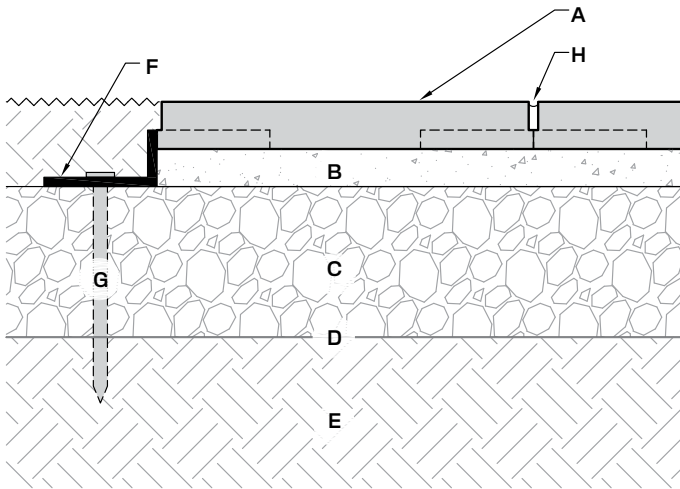

- A. Tetra Slab, 1.25" (32mm) thick
- B. Bedding sand (ASTM C33) min. 1" (25mm)
- C. Dense graded base, min. 4" (100mm), compacted
- D. Woven geotextile fabric (recommended)
- E. Compacted subgrade soil
- F. Low profile paver edge restraint
- G. Steel spike
- H. Joint sand (ASTM C144)

TYPICAL WET-SET INSTALLATION

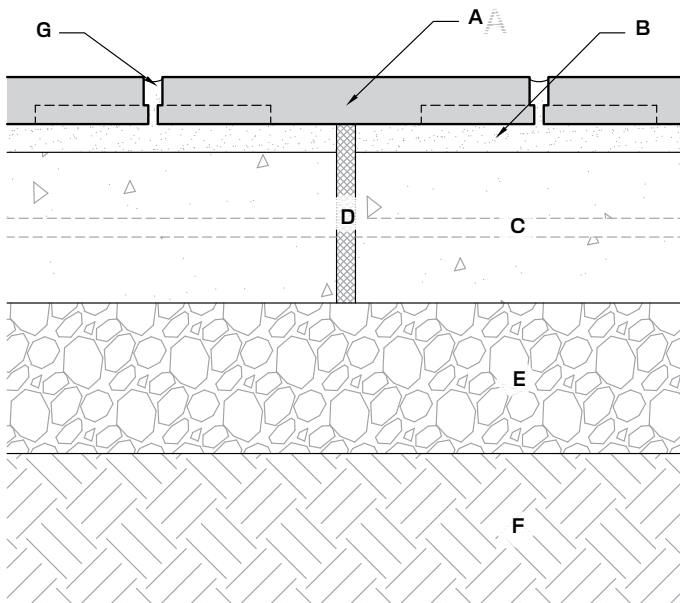

- A. Tetra Slab, 1.25" (32mm) thick
- B. Latex mortar, min. 3/4" (20mm)
- C. Reinforced concrete slab, min. 4" (100mm)
- D. Expansion joint, 1/2" (13mm)
- E. Dense graded base, min. 4" (100mm) compacted
- F. Compacted subgrade soil
- G. Latex mortar joint, 1/2" (13mm) recommended



GRAND FLAGSTONE

FEATURES

- 15 unique shapes replicate large, irregular flagstone with natural stone texture
- Fast installations with easy-to-install pattern
- Uniform thickness creates a more consistent walking surface
- High strength concrete means long term durability
- Multiple natural color blends available

PALLET

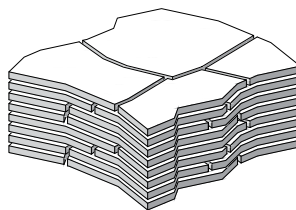

Dimensions: 42"L x 42"W x 24"H
 Weight: 2,000± lbs (inc. pallet)
 Coverage: 90 sq ft (assumes 3/8" joint)
 Layers Per Pallet: 8 (random assortment of layers)

MATERIAL

WETCAST

VIBRALOCK®

Refer to our website for the most recent color offerings.



Learn More

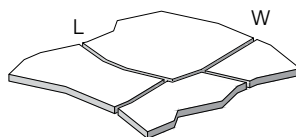

LAYER: 1

Dimensions: 42"L x 38"W x 1.75"H
 Weight: 245 lbs

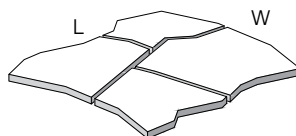

LAYER: 2

Dimensions: 42"L x 38"W x 1.75"H
 Weight: 245 lbs

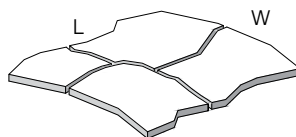

LAYER: 3

Dimensions: 42"L x 38"W x 1.75"H
 Weight: 245 lbs

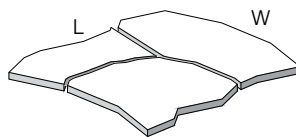

LAYER: 4

Dimensions: 42"L x 38"W x 1.75"H
 Weight: 245 lbs

GRAND FLAGSTONE

INTERLOCKING LAYERS

COMMON POINTS

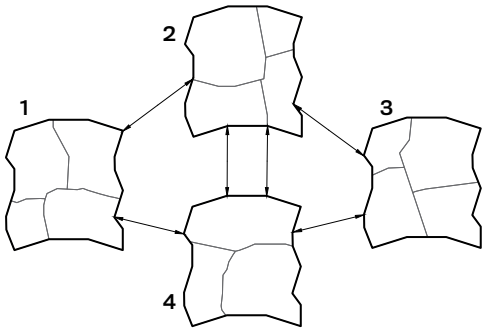

PROPER PLACEMENT

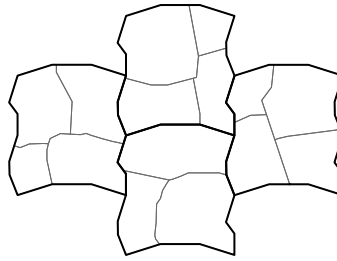

Note: Outside dimensions of each layer are identical to all other layers, allowing any layer to be substituted anywhere in the pattern.

± 3/8" joints (typical)

PATTERNS - PATIO

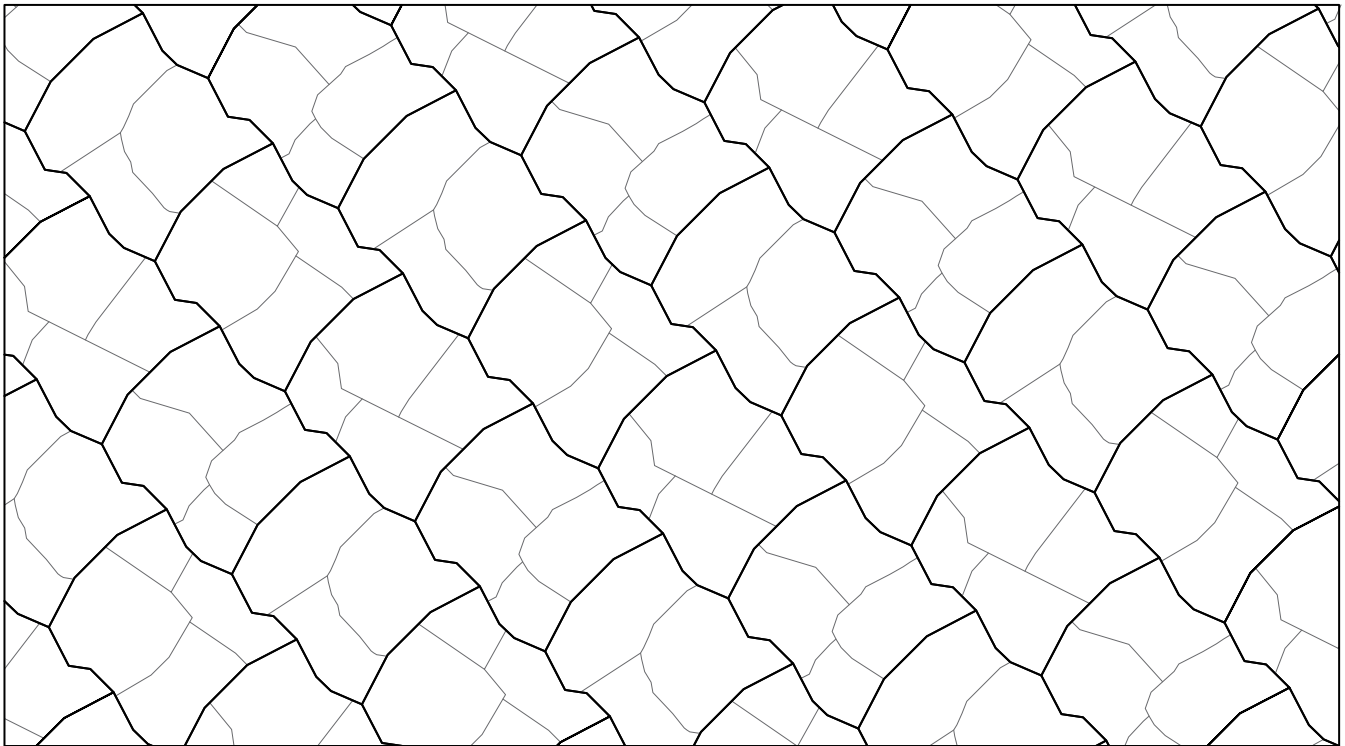

WALKWAY

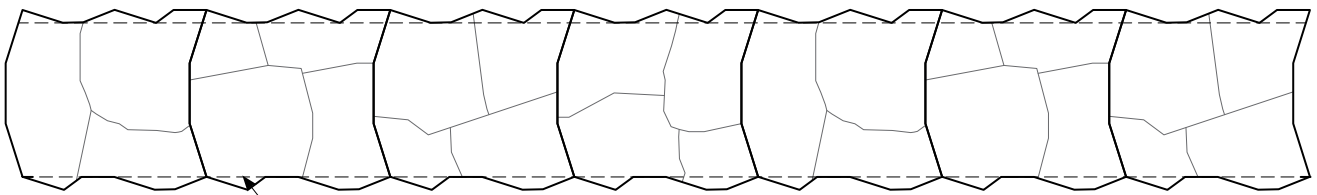

Leave jagged edge or trim to provide smooth edge (optional)

LAYOUT ORIENTATION

INCORRECT

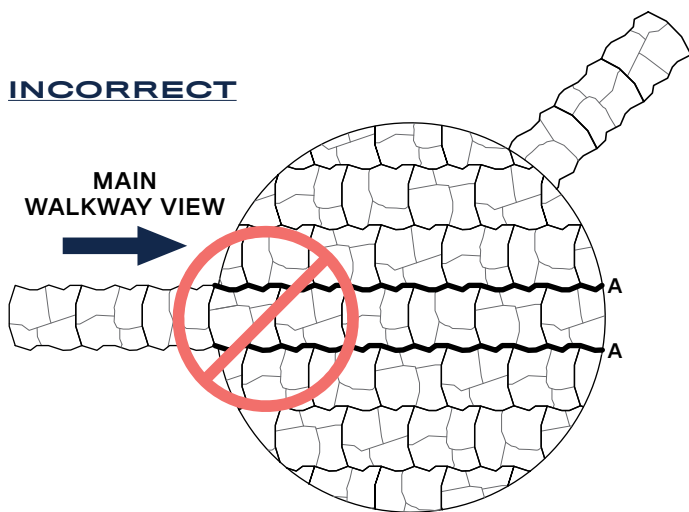

Layout orientation is important with Grand Flagstone. Due to the nature of the interlocking sets of slabs, there are long, unbroken joints between rows. Often, the irregular nature of the Grand Flagstone limits how noticeable these unbroken joints are in the finished project. However, the lines become slightly more noticeable when you are looking parallel to the unbroken joints than when you are looking at them on an angle. To limit this effect, Grand Flagstone layers should be laid at a 45 degree angle from the most common viewing angle. This viewing angle would most likely be a patio entrance or step location.

A. Long, unbroken lines caused by seam between layers

CORRECT

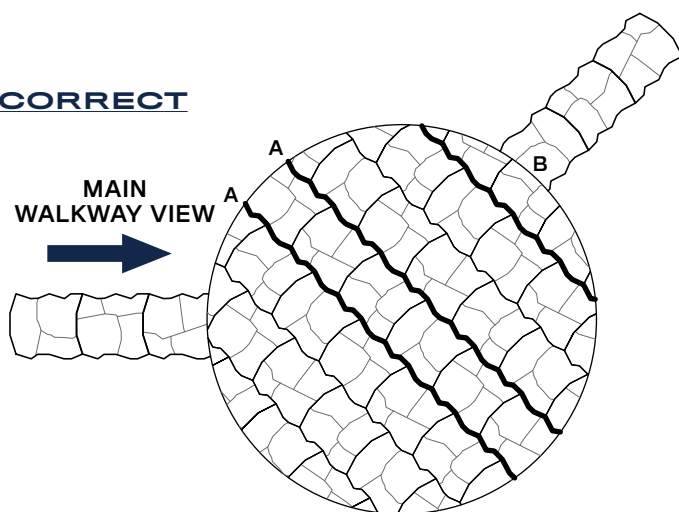

A. Long, unbroken lines caused by seam between layers oriented at 45° angle from main view

B. Long, unbroken lines caused by seam between layers oriented as close to 45° angle from secondary view as possible

PROCEDURE FOR INSTALLING CRACKED PIECES

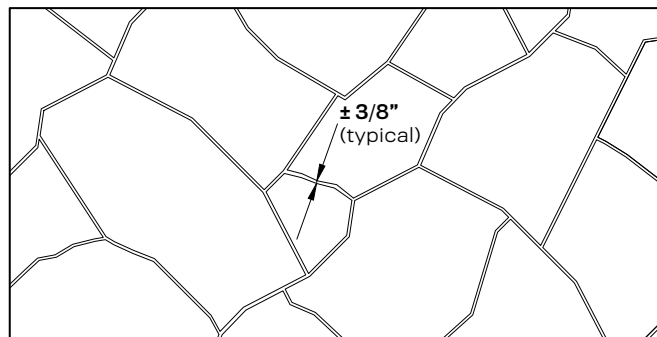

- Trim Broken Edges if needed
- Install Pieces with Typical 3/8"(10 mm) Joint

Individual pieces of Grand Flagstone can crack either during delivery to the job or during on-site handling prior to placement. Typically less than 5% of the pieces will crack. There are two methods to deal with cracked pieces.

The first method is to use the cracked pieces to fill in around the perimeter of the project where there is always a need for small pieces.

The second method is to use the cracked pieces to enhance the layout pattern. Since Grand Flagstone is designed to create an irregular flagstone walking surface, an extra crack simply provides another joint line in the Grand Flagstone pattern. Place the cracked pieces next to each other with a 3/8" (10 mm) joint between them. The joint is filled with polymeric jointing sand just like all the other joints. If necessary, the cracked pieces may need to be trimmed to create a smoother edge or provide a larger joint to match all the other joints in your project.

INSTALLATION GUIDE

BEDDING SAND INSTALLATION

Using screed rails on the compacted granular base, apply bedding sand at a maximum thickness of 1" (25mm). By using a screed board along the top of the screed rails, the bedding sand will level evenly. Bedding sand should be compacted since Grand Flagstone slabs should not be compacted after installation.

FLAGSTONE INSTALLATION

- Begin by laying the individual pieces of Grand Flagstone on the screeded bedding material according to your detailed project plan.
- Separate individual pieces approximately 3/8" (10 mm) from each other. When units are set with a 3/8" gap, a full pallet will produce 90 square feet (8.36 m²) of coverage.
- Cut units as needed to finish edges.
- NOTE: To ensure proper color distribution, mix layers from several bundles at one time.

Plate compaction of Grand Flagstone slabs after installation is not necessary, and is also not recommended. Use of plate compaction on Grand Flagstone will void the warranty.

JOINT SAND INSTALLATION

Once the flagstone pieces are installed, fill all joints with jointing sand suitable for large joints. Sweep the sand into the joints between flagstones until the joints are completely filled. Follow the jointing sand manufacturer's recommendations for wetting the sand. You may need to repeat this process with more dry sand in a few days to completely fill the joints between individual slabs.

GENERAL NOTES FOR DETAIL

This page shows a typical detail for Grand Flagstone.

- This drawing is for preliminary reference only (not for final construction).
- **Final designs for construction must be prepared by a registered professional engineer using the actual conditions of the proposed site and loads.**
- Block size and placement shown are for reference only, individual blocks vary with installation pattern.
- Section shown is the minimum recommendation for pedestrian loading. Projects with heavier traffic or sites with poor soil conditions may require thicker gravel base, concrete curb edge restraint, and/or sand subbase.
- Provide adequate surface drainage to prevent ponded water.

TYPICAL RESIDENTIAL INSTALLATION

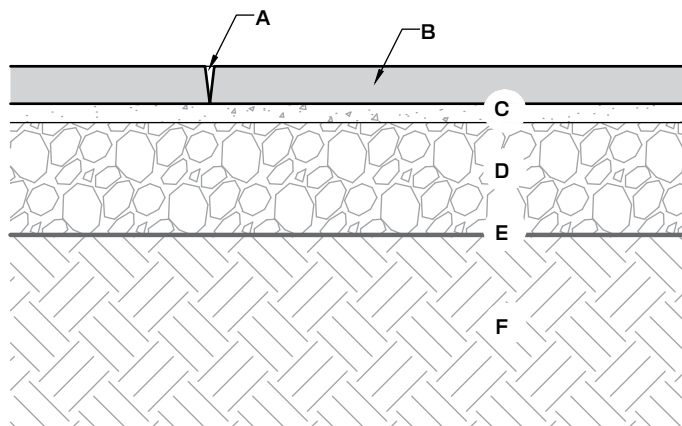

INTERLOCKING LAYERS

Grand Flagstone has been designed so each layer of slabs on a pallet is an interlocking set. Each interlocking set, or layer, of slabs has been designed to interlock with all other layers.

OTHER CONSIDERATIONS

Not suitable for vehicular traffic.



DIMENSIONAL FLAGSTONE

FEATURES

- Six unique shapes with 24 unique stone textures
- Uniform thickness and accurate dimensions translates into fast installation and a beautiful end result

MATERIAL

WETCAST
VIBRALOCK®

Refer to our website for the most recent color offerings.



Learn More

PALLET

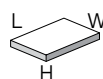
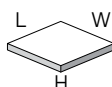
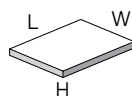
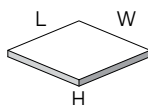
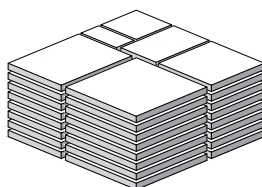

Weight: 2,350± lbs (inc. pallet)
Coverage: 98 sq ft
Layers Per Pallet: 8
Section: 12.25 sq ft per layer

UNIT: 24 X 24

Dimensions: 24"L x 24"W x 2"H
Weight: 96 lbs
Coverage: 4 sq ft
Units Per Pallet: 8

UNIT: 24 X 18

Dimensions: 24"L x 18"W x 2"H
Weight: 72 lbs
Coverage: 3 sq ft
Units Per Pallet: 8

UNIT: 18 X 18

Dimensions: 18"L x 18"W x 2"H
Weight: 54 lbs
Coverage: 2.25 sq ft
Units Per Pallet: 8

UNIT: 18 X 12

Dimensions: 18"L x 12"W x 2"H
Weight: 36 lbs
Coverage: 1.5 sq ft
Units Per Pallet: 8

UNIT: 12 X 12

Dimensions: 12"L x 12"W x 2"H
Weight: 24 lbs
Coverage: 1 sq ft
Units Per Pallet: 8

UNIT: 12 X 6

Dimensions: 12"L x 6"W x 2"H
Weight: 12 lbs
Coverage: .5 sq ft
Units Per Pallet: 8

DIMENSIONAL FLAGSTONE

PATTERNS - PATIO

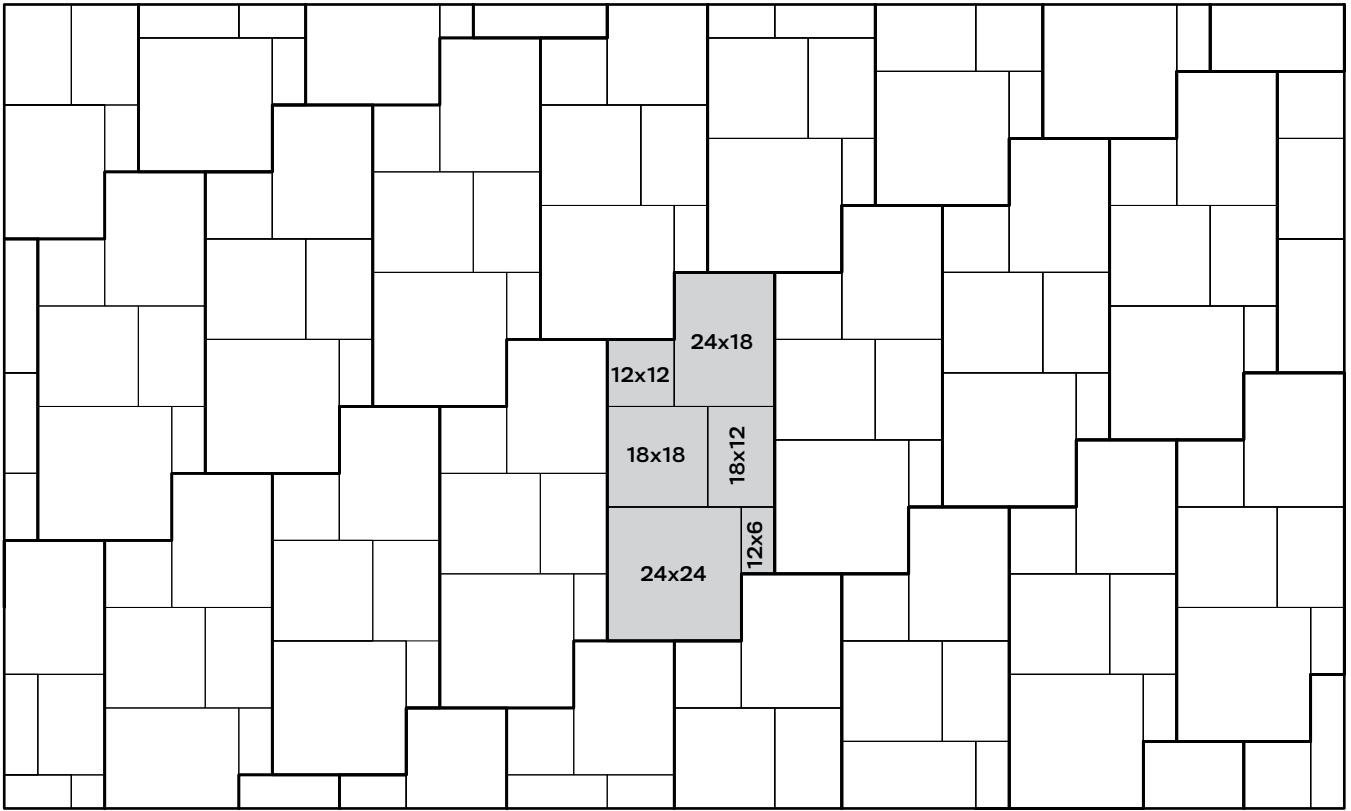

WALKWAY

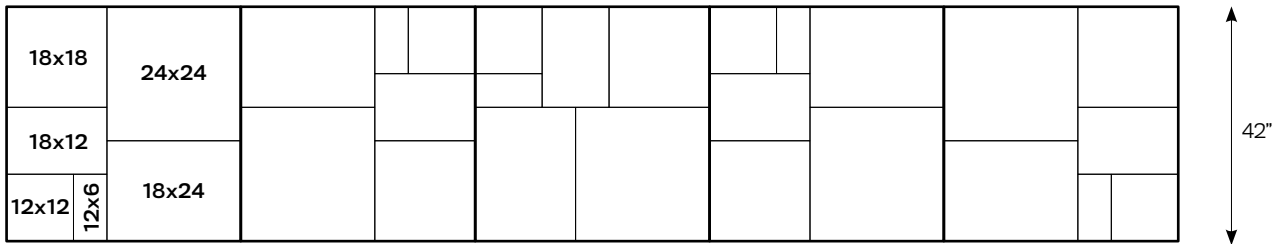

INSTALLATION GUIDE

BEDDING SAND INSTALLATION

Using screed rails on the compacted granular base, apply bedding sand at a maximum thickness of 1" (25mm). By using a screed board along the top of the screed rails, the bedding sand will level evenly.

FLAGSTONE INSTALLATION

- Begin by laying the individual pieces of Dimensional Flagstone on the screeded bedding material according to your detailed project plan.
- Push flagstone slabs directly together so the bottom edges butt tight. There is no need to space the slabs to create the necessary joint. Joint is pre-set in the unit.
- Cut units as needed to finish edges of installation.
- NOTE: To ensure proper color distribution, mix layers from several bundles at one time.

Plate compaction on the surface of Dimensional Flagstone slabs is not necessary, and is also not recommended. Use of plate compaction on the surface of Dimensional Flagstone will void the warranty.

JOINT SAND INSTALLATION

Once the flagstone pieces are installed, fill all joints with jointing sand suitable for large joints. Sweep the sand into the joints between flagstones until the joints are completely filled. Follow the jointing sand manufacturer's recommendations for wetting the sand. You may need to repeat this process with more dry sand in a few days to completely fill the joints between individual slabs.

OTHER CONSIDERATIONS

Not suitable for vehicular traffic.

GENERAL NOTES FOR DETAILS

This page shows a typical detail for Dimensional Flagstone.

- This drawing is for preliminary reference only (not for final construction).
- **Final designs for construction must be prepared by a registered professional engineer using the actual conditions of the proposed site and loads.**
- Block size and placement shown are for reference only, individual blocks vary with installation pattern and product.
- Section shown is the minimum recommendation for pedestrian loading. Projects with heavier traffic or sites with poor soil conditions may require thicker gravel base, concrete curb edge restraint, and/or sand subbase.
- Provide adequate surface drainage to prevent ponded water.

TYPICAL RESIDENTIAL INSTALLATION

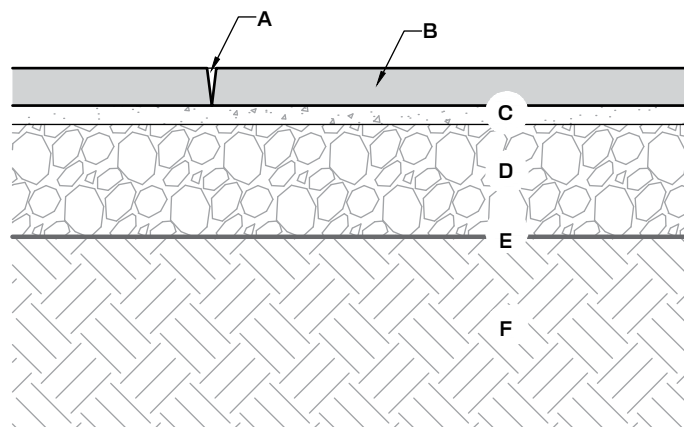

- A. Polymeric jointing sand between slabs
- B. Dimensional Flagstone Slabs (2" (51 mm) thick)
- C. Coarse bedding sand (1" (25 mm) thick)
- D. Compacted gravel base (6" (150 mm) thick)
- E. Woven geotextile (optional)
- F. Suitable, compacted subgrade



NEW MISSION

FEATURES

- Interlocking pavement on a generous scale, with showstopping texture and an elegant “random” pattern perfect for a pedestrian walkway
- Three sizes and multiple face textures
- Suitable for residential vehicular traffic

MATERIAL

WETCAST
VIBRALOCK®

Refer to our website for the most recent color offerings.



[Learn More](#)

PALLET

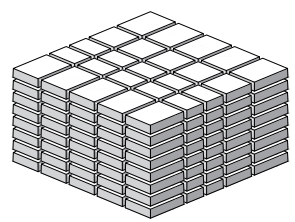

Weight: 3,050± lbs (inc. pallet)
 Coverage: 100 sq ft
 Linear Feet (Soldier Course): 140 ft
 Layers Per Pallet: 8
 Section: 12.5 sq ft per layer



UNIT: 6 X 9

Dimensions: 5 11/16" L x 8 1/2" W x 2 3/4" H
 Weight: 10 lbs
 Coverage: .33 sq ft
 Units Per Pallet: 80



UNIT: 9 X 9

Dimensions: 8 1/2" L x 8 1/2" W x 2 3/4" H
 Weight: 15 lbs
 Coverage: .5 sq ft
 Units Per Pallet: 40



UNIT: 9 X 12

Dimensions: 11 5/16" L x 8 1/2" W x 2 3/4" H
 Weight: 20 lbs
 Coverage: .66 sq ft
 Units Per Pallet: 80

NEW MISSION

PATTERNS - PATIO

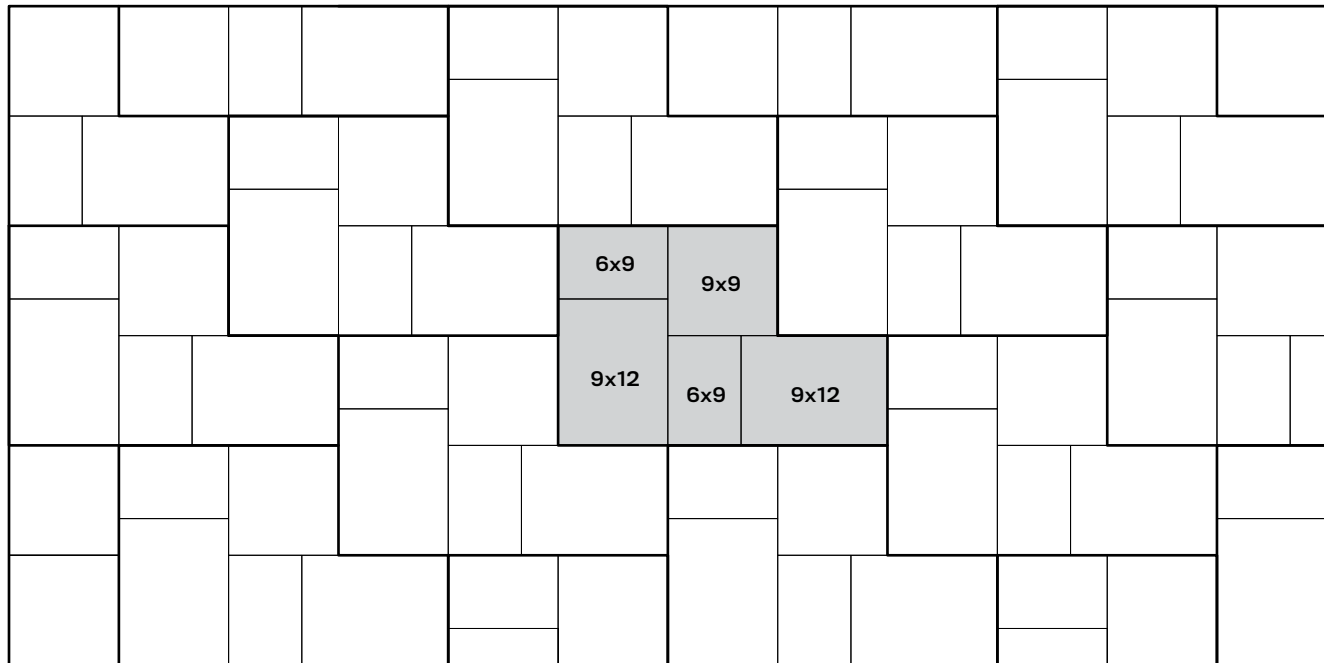

BORDER COURSE

Each size paver has a 9" side. Run these sides end-over-end to create a border course to border your driveway, patio and walkways. For added aesthetic value, use a different color paver for the border course.

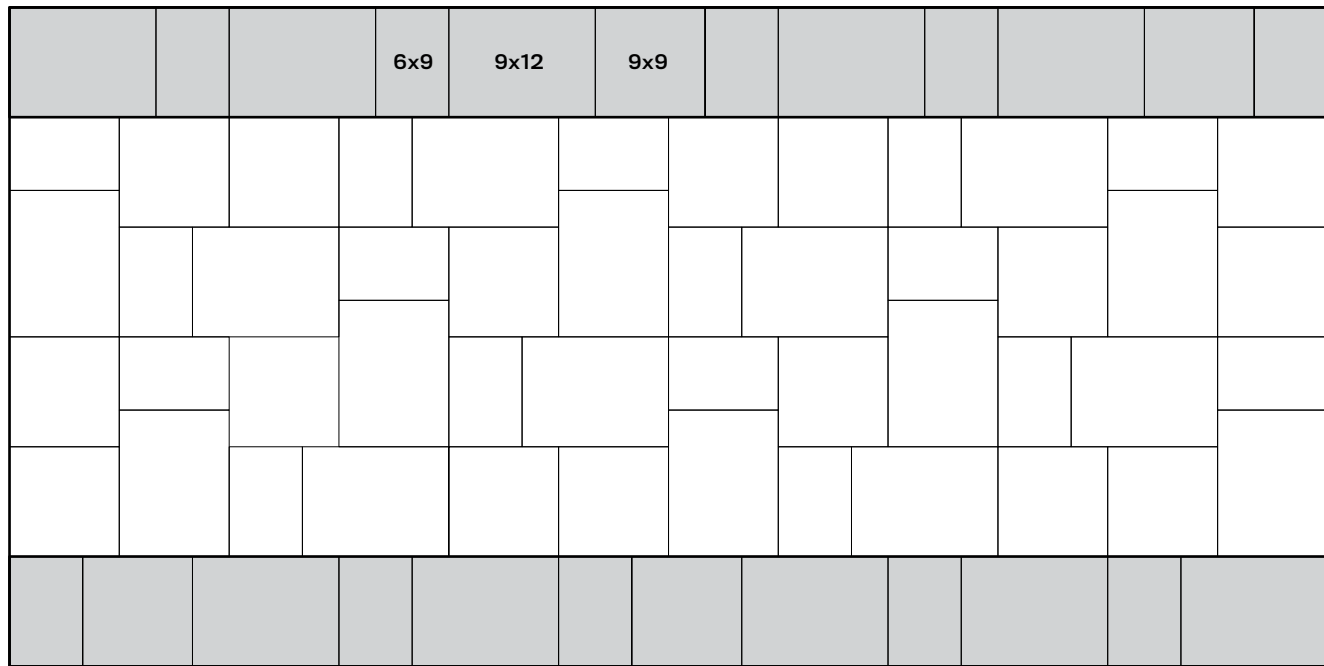

GENERAL NOTES FOR DETAILS

This page shows typical details for New Mission Pavers.

- These drawings are for preliminary reference only (not for final construction).
- Final designs for construction must be prepared by a registered professional engineer using the actual conditions of the proposed site and loads.
- Block size and placement shown are for reference only.
- Sections shown are the minimum recommendations.
- Adequate surface drainage should be provided to prevent ponded water.
- These sections are not intended for permeable pavement applications.
- When snowplowing New Mission Pavers, a poly cutting edge must be used to avoid marking the surface of the paver.

TYPICAL PEDESTRIAN AND RESIDENTIAL VEHICULAR DETAIL

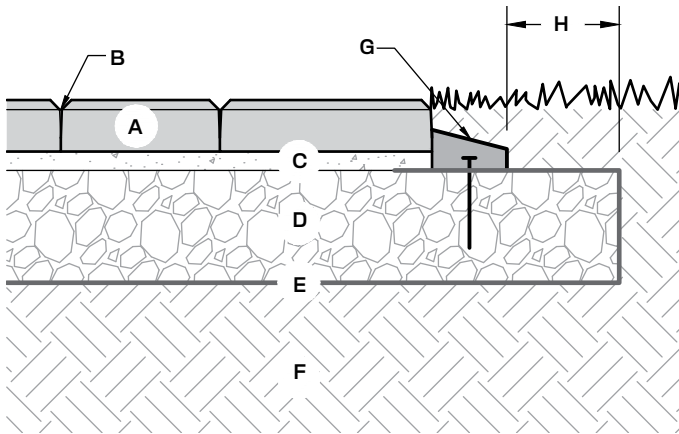

- A. New Mission Pavers (2.75" (70 mm) thick)
- B. Polymeric jointing sand between pavers
- C. Bedding sand, ASTM C33, <1% finer than 0.075 mm (1" (25 mm) thick)
- D. Compacted dense-graded gravel base (minimum 6" (152 mm) thick)
- E. Woven geotextile (as required)
- F. Compacted suitable subgrade
- G. Plastic or metal edging strip
- H. 6" (152 mm) minimum

Commercial projects with vehicular traffic or sites with poor soil conditions may require thicker gravel base, concrete curb edge restraint, and/or sand subbase.

TYPICAL LIGHT COMMERCIAL VEHICULAR DETAIL

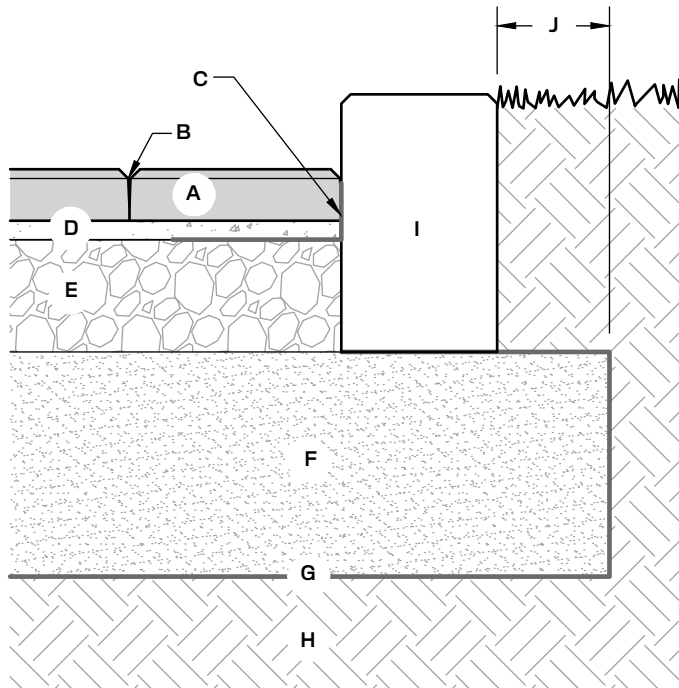

- A. New Mission Pavers (2.75" (70 mm) thick)
- B. Polymeric jointing sand between pavers
- C. 12" (305 mm) wide geotextile turned up against curb
- D. Bedding sand, ASTM C33, <1% finer than 0.075 mm (1" (25 mm) thick)
- E. Compacted dense-graded gravel base (minimum 8" (203 mm) thick)
- F. Free-draining sand subbase (minimum 12" (305 mm) thick, if required)
- G. Woven geotextile (as required)
- H. Compacted suitable subgrade
- I. Cast-in-Place concrete edging or curb
- J. 6" (152 mm) minimum

Section is suitable for vehicular applications assuming <100,000 equivalent single axle loads (ESALs), competent subgrade with California bearing ratio (CBR) >5, and low speeds (<25 mph (40 kph)).

Subgrade preparation, subbase requirements, and subsurface draining requirement should be determined by the project geotechnical engineer.



SUPERIOR STEPPERS

FEATURES

- Eight different shapes for a rustic, authentic stone appearance
- Various color offerings compliment your existing backyard environment

MATERIAL WETCAST

Refer to our website for the most recent color offerings.



Learn More

PALLET

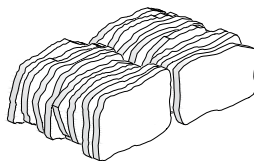

Weight: 1,300 lbs (inc. pallet)
 Coverage: 52 sq ft
 Pieces Per Pallet: 16 (random assortment)
 Section: 3.25 sq ft per 1 piece

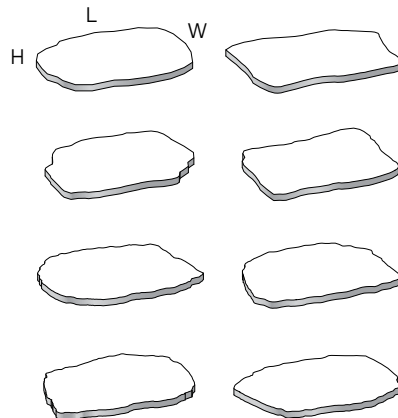

UNITS: 1 - 8

Dimensions: 27"L x 21"W x 2"H
 Weight: 78 lbs
 Coverage: 3.25 sq ft

GENERAL NOTES FOR DETAILS

This page shows a typical detail for Superior Steppers.

- This drawing is for preliminary reference only (not for final construction).
- Block size and placement shown are for reference only, individual steps vary with installation pattern.

TYPICAL INSTALLATION

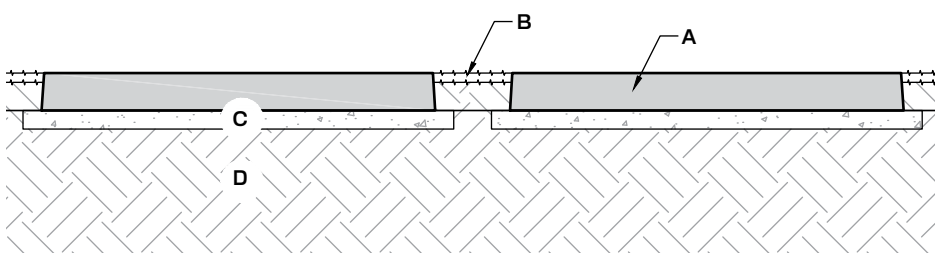

- A. Superior Stepper Stone (2" (50 mm) thick)
- B. Turf between Superior Stepper stones
- C. Coarse bedding sand min. 1" (25 mm) thick compacted
- D. Compacted existing sub-grade

STEPS

GENERAL INFORMATION
EMPIRE
DIMENSIONAL
IRREGULAR

INSTALLATION GUIDE

BASIC STEP INSTALLATION NOTES FOR:

- Empire
- Dimensional
- Irregular

Refer to product pages for specific information and details pertaining to individual products.

MEASUREMENTS

Begin the step installation process by measuring the total rise required and calculating the number of steps to be used. Each step has a 7" rise, but should be sloped approximately 1/2" such that the back of the step is higher than the front of the step. This slope will facilitate surface water drainage. With appropriate sloping, the net rise of each step is 7-1/2". Divide the total rise by 7-1/2" to get the number of steps required.

CALCULATIONS

Next, calculate the tread width. Generally, when the grade allows, a 12" or wider tread is desirable. To calculate the tread width, divide the total allowable horizontal run minus the width of the top step, by the number of steps minus one. The one less will account for the top step.

CONSIDER THE FOLLOWING EXAMPLE:

Total rise = 45", Total horizontal run = 94", Width of top step = 24",
Rise of steps = 7",

Number of steps = $45" \div 7\text{-}1/2"/\text{Step} = 6$ Steps

Tread Depth = $(94"-24") \div (6-1) = 14"$ Tread Depth

EXCAVATION

Excavate and grade the area for the first step. Steps should be placed on at least 3" of free draining soil, such as sand or pea-stone. Compact soil to a minimum of 95% standard proctor.

PLACEMENT

Place step with straps, a gravity lifting clamp, or a vacuum lift using a small excavator or skid-steer to lift the piece into place. Practice safe handling procedures during this process.

FILL

Fill behind each step with free draining soil and compact to 95% standard proctor. Remember to slope fill to allow for proper drainage when next step is placed. Continue placing steps in this manner until finish grade is reached.

TYPICAL STEP INSTALLATION DETAILS

This page shows a typical detail for steps.

- This drawing is for preliminary reference only (not for final construction).
- **Final designs for construction must be prepared by a registered professional engineer using the actual conditions of the proposed site and loads.**
- Block size and placement shown are for reference only, individual steps vary with installation pattern.

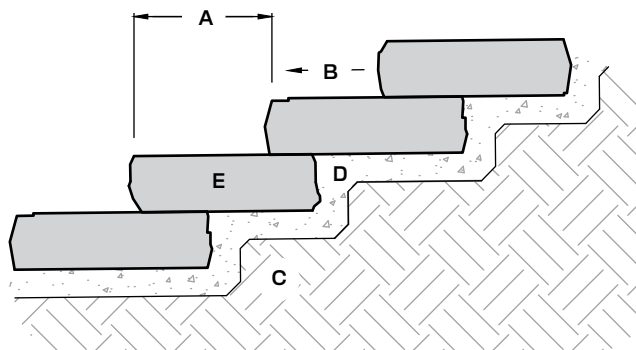

- A. Tread width varies (12" or more is desirable)
- B. Slope 1-2% (to allow drainage)
- C. Compact subbase material to a minimum of 95% max. dry density (or as specified by Engineer)
- D. Free-draining granular material (3" thick minimum compact to a min. of 95% max. dry density)
- E. Step block



EMPIRE

FEATURES

- Beautiful and durable step treads with a crisp splitface texture on all four sides
- A lightly textured walking surface
- Consistent rise equals fast installation and safe end result
- Quality materials and long term durability

MATERIAL WETCAST

Refer to our website for the most recent color offerings.



Learn More

SPLITFACE



3' STEP PALLET

Weight: 3,050± lbs (inc. pallet)

Pieces Per Pallet: 8



UNIT

Dimensions: 36"L x 18"W x 7"H (nominal)

Weight: 375± lbs

4' STEP PALLET

Weight: 3,800± lbs (inc. pallet)

Pieces Per Pallet: 6

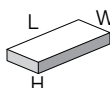

UNIT

Dimensions: 48"L x 21"W x 7"H (nominal)

Weight: 625± lbs

5' STEP PALLET

Weight: 3,400± lbs (inc. pallet)

Pieces Per Pallet: 4

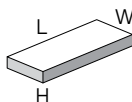

UNIT

Dimensions: 60"L x 24"W x 7"H (nominal)

Weight: 835± lbs

6' STEP PALLET

Weight: 4,000± lbs (inc. pallet)

Pieces Per Pallet: 3

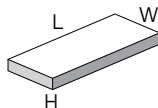

UNIT

Dimensions: 72"L x 30"W x 7"H (nominal)

Weight: 1,320± lbs

8' STEP PALLET

Weight: 4,200± lbs (inc. pallet)

Pieces Per Pallet: 3

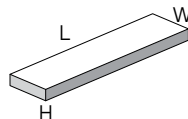

UNIT

Dimensions: 96"L x 24"W x 7"H (nominal)

Weight: 1,375± lbs

18" RISER PALLET

Weight: 2,200± lbs (inc. pallet)

Pieces Per Pallet: 24



UNIT

Dimensions: 18"L x 7"W x 7"H (nominal)

Weight: 90± lbs

36" RISER PALLET

Weight: 2,000± lbs (inc. pallet)

Pieces Per Pallet: 12



UNIT

Dimensions: 36"L x 7"W x 7"H (nominal)

Weight: 160± lbs



DIMENSIONAL

FEATURES

- Stone-like shapes and textures create inviting walkways
- Consistent rise equals fast installation and safe end result
- Quality materials and long term durability
- Multiple natural color blends available
- Complimentary products offer a variety of creative possibilities

MATERIAL WETCAST

Refer to our website for the most recent color offerings.



[Learn More](#)

4' PALLET

Weight: 4,050± lbs (inc. pallet)
Pieces Per Pallet: 8

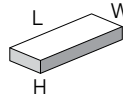

UNIT

Dimensions: 48"L x 18"W x 7"H
Weight: 500± lbs

SNAPPED FACE



6' PALLET

Weight: 4,000± lbs (inc. pallet)
Pieces Per Pallet: 3

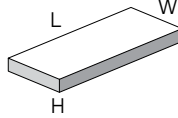

UNIT

Dimensions: 72"L x 30"W x 7"H
Weight: 1,320± lbs



IRREGULAR

FEATURES

- Stone-like shapes and textures create inviting walkways
- Consistent rise equals fast installation and safe end result
- Quality materials and long term durability
- Multiple natural color blends available
- Complimentary products offer a variety of creative possibilities

MATERIAL WETCAST

Refer to our website for the most recent color offerings.



Learn More

STANDARD 7" RISE PALLET

Weight: 4,200± lbs (inc. pallet)
 Pieces Per Pallet: 8 (random assortment)

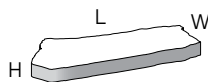

UNIT: 1

Dimensions: 54"L x 24"W x 7"H
 Weight: 458± lbs

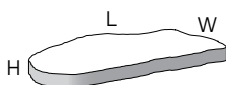

UNIT: 2

Dimensions: 60"L x 24"W x 7"H
 Weight: 600± lbs

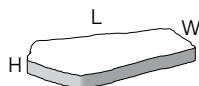

UNIT: 3

Dimensions: 48"L x 28"W x 7"H
 Weight: 567± lbs



UNIT: 4

Dimensions: 48"L x 24"W x 7"H
 Weight: 512± lbs

WEATHERED FACE



LARGE 6' PALLET

Weight: 3,900± lbs (inc. pallet)
 Pieces Per Pallet: 3 (random assortment)



UNIT: 1

Dimensions: 72"L x 30"W x 7"H
 Weight: 1,300± lbs

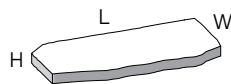

UNIT: 2

Dimensions: 72"L x 30"W x 7"H
 Weight: 1,300± lbs



UNIT: 3

Dimensions: 72"L x 30"W x 7"H
 Weight: 1,300± lbs

SNAPPED FACE



Individual steps cannot be requested, the pallets come in a random assortment.

All dimensions are nominal.

FIRE FEATURES

GENERAL INFORMATION

BELVEDERE® FIRE PIT

KODAH® FIRE PIT

DIMENSIONAL FIRE PIT

BASIC INSTALLATION NOTES FOR ROUND & SQUARE FIRE PIT KITS

- Belvedere® Fire Pit
- Dimensional Fire Pit
- Kodah® Fire Pit

Refer to product pages for specific information and details pertaining to individual products.

1. Familiarize yourself with the construction details in this Technical Guide.
2. Mark out the location for your fire pit. Note: Dimensions shown are nominal so mark an area slightly larger than shown.
3. Excavate for drain stone base (approx. 6")
4. Fill excavated area with drain stone, level, and compact.
5. Place and center steel ring on prepared base.
6. Place blocks per the pattern. (For round kit, keep blocks 1 1/2" off steel ring)
7. **WARNING!** Do not place the fire pit directly atop a patio surface. Instead, the fire pit should be "cut in" to the patio surface to avoid damage to the patio caused by conductive heat transfer.

ADDITIONAL STEPS ARE FOR ROUND FIRE PITS ONLY

8. After placing blocks around the ring, adjust the blocks in or out to make the circle close and fit tight. If the blocks do not close the circle, move all blocks slightly in. If the blocks seem too long, move the blocks slightly out.
9. Place caps in circle around fire pit. Adjust the caps in or out to make them fit tightly together.
10. Note: Not suitable for large fires. Fire size should not allow flame to contact caps on round fire pit.

Round and square fire pit kits are also available in gas-burning and Breeo® smokeless wood-burning configurations.



BELVEDERE® FIRE PIT

FEATURES

- Featuring the look of weathered fieldstone
- Includes 52 wetcast concrete stones and a 14-gauge steel liner

MATERIAL WETCAST

Refer to our website for the most recent color offerings and insert options.



Learn More

PALLET

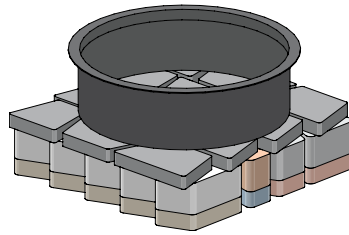

Dimensions: 42" L x 42" W x 30" H
Weight: 1,320 lbs (inc. pallet)

INSTALLED PLAN VIEW

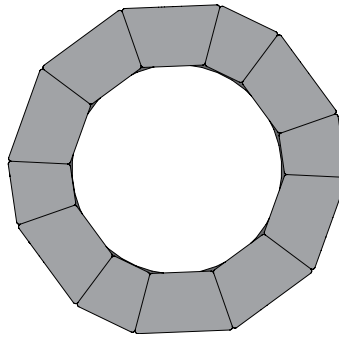

Finished
Dimensions: 58" Dia. x 14-1/2" H

TYPICAL INSTALLATION

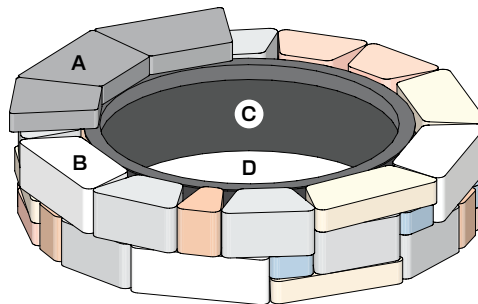

- A. Cap layer (three cap blocks shown for reference)
- B. Belvedere® Fire Pit blocks
- C. 14-gauge steel ring (37" dia. opening)
- D. 6" minimum drainstone base underneath

(See Block Pattern and Cross Section detail for more information)

BELVEDERE® FIRE PIT

BLOCK PATTERN ELEVATION

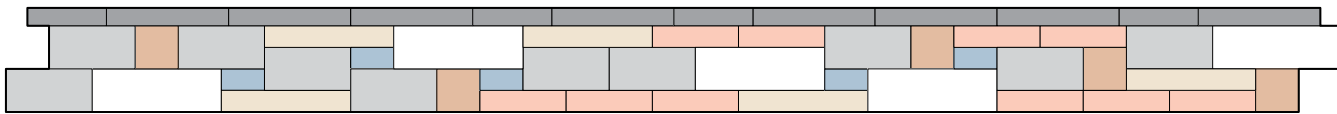

BLOCK KEY
(Nominal Dimensions)



CROSS SECTION

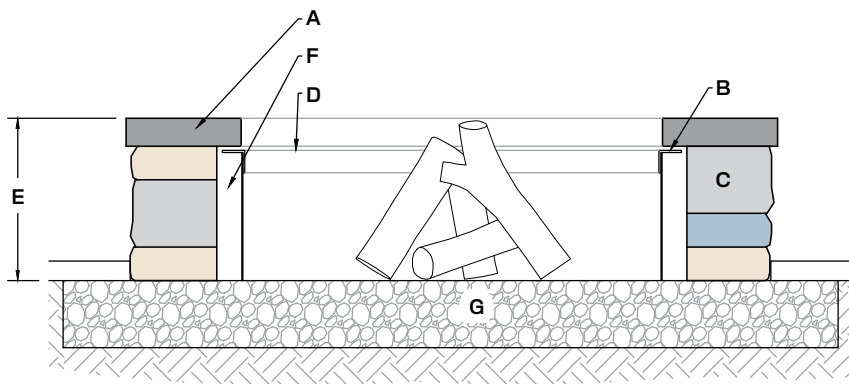

- A. Caps
- B. Caps do not contact lip of steel ring
- C. Belvedere® Fire Pit blocks
- D. 14-gauge steel ring (37" dia. opening)
- E. 14-1/2" overall height
- F. ±2" gap
- G. 6" minimum drainstone base underneath



KODAH® FIRE PIT

FEATURES

- Featuring the modern, clean aesthetic of snapped limestone
- Includes 16 wetcast concrete stones and a 12-gauge steel liner

MATERIAL WETCAST

Refer to our website for the most recent color offerings and insert options.



Learn More

PALLET

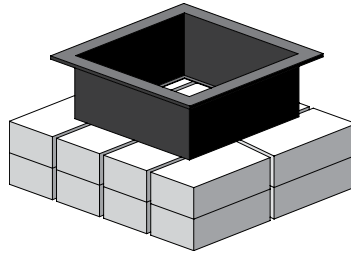

Dimensions: 48"x42"x30"
Weight: 1,700 lbs (inc. pallet)

INSTALLED PLAN VIEW

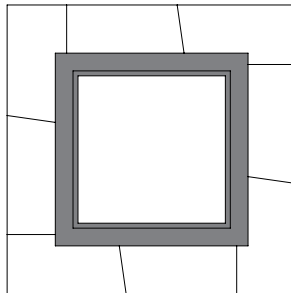

Finished Dimensions: 51"L X 51"W X 12"H

TYPICAL INSTALLATION

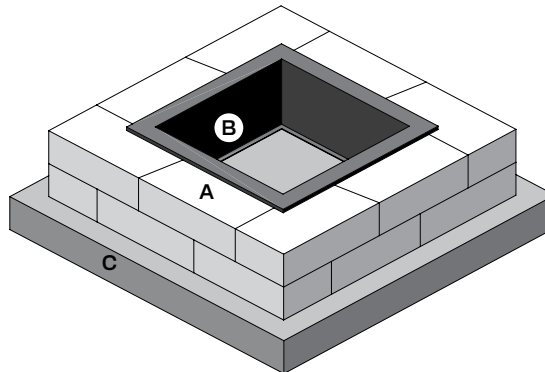

- A. Kodah® wall blocks (overlap at corners as shown, and abut matching block tapers)
- B. 12-gauge steel ring (28"x28" opening), 12" tall, hangs directly on blocks
- C. 6" minimum drainstone base underneath



DIMENSIONAL FIRE PIT

FEATURES

- Featuring the texture of quarried stone
- Includes 36 wetcast concrete stones and a 12-gauge steel liner

MATERIAL WETCAST

Refer to our website for the most recent color offerings and insert options.



Learn More

PALLET

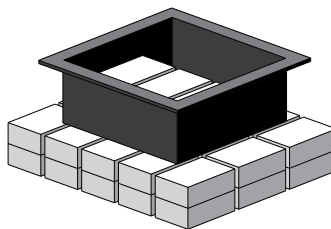

Dimensions: 42"x42"x30"
Weight: 1,130 lbs (inc. pallet)

INSTALLED PLAN VIEW

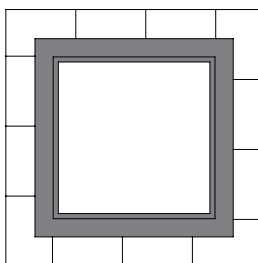

Finished
Dimensions: 44" L X 44" W X 12" H

TYPICAL INSTALLATION

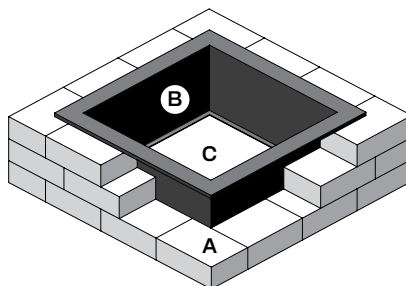

- A. Dimensional wall blocks (overlap at corners as shown)
- B. 12-gauge steel ring (28"x28" opening), 12" tall, hangs directly on blocks
- C. 6" minimum drainstone base underneath

COPING & CAPS

**DIMENSIONAL COPING
CAMDEN COPING
BELVEDERE® COPING
DIMENSIONAL CAPS
CAMDEN CAPS**



DIMENSIONAL COPING

FEATURES

- Chiseled, natural stone texture
- Comfortable dimensions for seat walls
- Formal appearance perfect for any wall application

MATERIAL

WETCAST

Refer to our website for the most recent color offerings.



Learn More

PALLET

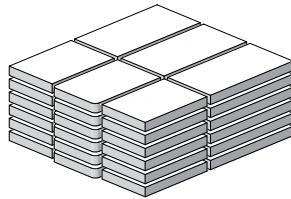

Weight: 2,000 lbs (inc. pallet)
 Linear Feet: 63
 Layers Per Pallet: 6
 Section: 10.5 linear ft per layer

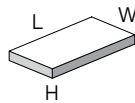

UNIT: 24"

Dimensions: 24"L x 12.5"W x 2.5"H
 Weight: 63± lbs
 Units Per Pallet: 18

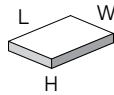

UNIT: 18"

Dimensions: 18"L x 12.5"W x 2.5"H
 Weight: 47± lbs
 Units Per Pallet: 12

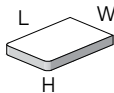

UNIT: COPING END

Dimensions: 19"L x 12.5"W x 2.5"H
 Weight: 49± lbs
 Units Per Pallet: 6



CAMDEN COPING

FEATURES

- An attractive wall accent or stair tread
- Rock-faced on front and back, with a lightly surfaced top and a wear-proof surface
- Resistant to UV degradation

PALLET

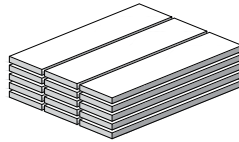

Weight:	1,550± lbs (inc. pallet)
Linear Feet:	60
Layers Per Pallet:	5
Section:	4 linear ft per piece

MATERIAL

TEKTRAMAT®

Refer to our website for the most recent color offerings.

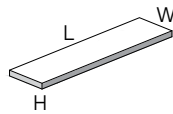

UNIT

Dimensions:	48"L x 12"W x 2"H
Weight:	100± lbs
Units Per Pallet:	15



Learn More



BELVEDERE® COPING

FEATURES

- Multiple face textures for each basic block size provide a more random look for your finished project
- Three standard coping blocks are finished on the front, back and top faces with an approximate 1" taper on each side from the front to the back of the block
- Two end units are finished on the front, back, top and one of the sides with approximate 1" taper on one side from the front to the back of the block
- End units are useful for constructing corners and ends

PALLET

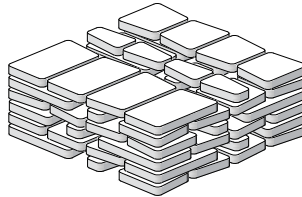

Weight: 1,550± lbs (inc. pallet)
 Linear Feet: 66
 Layers Per Pallet: 6
 Section: 11 linear ft per layer

MATERIAL WETCAST

Refer to our website for the most recent color offerings.



[Learn More](#)



UNIT: 9

Dimensions: 6"L x 10.25"W x 2.25"H
 Weight: 10± lbs
 Units Per Pallet: 24



UNIT: 10

Dimensions: 12"L x 10.25"W x 2.25"H
 Weight: 20± lbs
 Units Per Pallet: 24

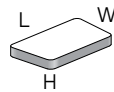

UNIT: 11

Dimensions: 18"L x 10.25"W x 2.25"H
 Weight: 30± lbs
 Units Per Pallet: 12

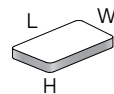

UNIT: 12 (LEFT END)

Dimensions: 18"L x 10.25"W x 2.25"H
 Weight: 30± lbs
 Units Per Pallet: 6

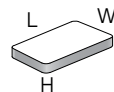

UNIT: 13 (RIGHT END)

Dimensions: 18"L x 10.25"W x 2.25"H
 Weight: 30± lbs
 Units Per Pallet: 6

DIMENSIONAL CAP

FEATURES

- Dimensional, chiseled face
- Large format and subtle textures
- Designed to coordinate with HIGH FORMAT® wall products

MATERIAL WETCAST

Refer to our website for the most recent color offerings.



[Learn More](#)

24" CAP PALLET

Weight: 1,300± lbs (inc. pallet)

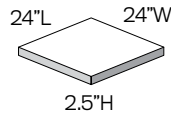

UNIT: 24"

Weight: 120± lbs
Units Per Pallet: 10

30" CAP PALLET

Weight: 1,400± lbs (inc. pallet)

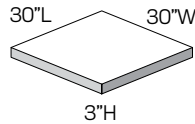

UNIT: 30"

Weight: 230± lbs
Units Per Pallet: 6

34" CAP PALLET

Weight: 1,800± lbs (inc. pallet)

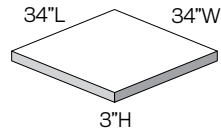

UNIT: 34"

Weight: 295± lbs
Units Per Pallet: 6

27" CAP PALLET (BELVEDERE® TEXTURE)

Weight: 1,600± lbs (inc. pallet)

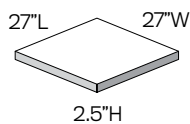

UNIT: 27"

Weight: 150± lbs
Units Per Pallet: 10



CAMDEN CAP

FEATURES

- Durable and attractive pillar caps
- Rock-faced on four sides, with a lightly textured top
- Resistant to UV degradation

MATERIAL

TEKTRAMAT®

Refer to our website for the most recent color offerings.



Learn More

24" CAP PALLET

Weight: 700± lbs (inc. pallet)

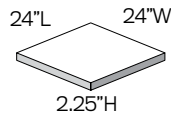

UNIT: 24"

Weight: 110± lbs
Units Per Pallet: 6

28" CAP PALLET

Weight: 950± lbs (inc. pallet)

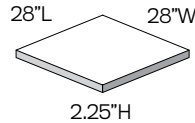

UNIT: 28"

Weight: 150± lbs
Units Per Pallet: 6

34" CAP PALLET

Weight: 1,400± lbs (inc. pallet)

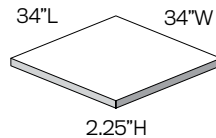

UNIT: 34"

Weight: 225± lbs
Units Per Pallet: 6

LIFETIME LIMITED WARRANTY

We want you to feel comfortable and confident when starting your project. That's why we make sure you have the resources you need to get the job done right. Everything we make, we back with a lifetime limited warranty.

HIGH FORMAT® products as manufactured by HIGH FORMAT® are backed by a lifetime limited warranty from the manufacturer to the original end user for products used in residential applications. This assurance of product quality guarantees the structural integrity of these products and is applicable where products have been correctly installed to manufacturer's specifications. Any properly installed hardscape material manufactured by HIGH FORMAT® that structurally fails due to the concrete in the product not meeting the design strength specification will be replaced by the manufacturer. The following items are not covered by this warranty: color variances and the appearance of surface stains resulting from chemical reasons such as efflorescence or differential curing; damage caused by installation, misuse or abuse of the materials; deterioration caused by de-icing salts or fertilizers; damage resulting from sub-grade settlement or movement, hairline cracks that do not affect the structural performance of the product, spalling of less than three percent of the surface area, contact with chemicals or paint, discoloration due to airborne contamination, staining, oxidation, or improper sealing (collectively, "Exclusions"). Products purchased must be registered with the manufacturer within 60 days of end user's purchase for warranty to be valid. You may register your project at HIGHFORMAT.COM/WARRANTY.

HIGH FORMAT® EXPRESSLY DISCLAIMS ANY WARRANTY, EXPRESS OR IMPLIED, RELATED TO THE EXCLUSIONS DESCRIBED ABOVE. FURTHER, HIGH FORMAT® EXPRESSLY DISCLAIMS ANY WARRANTY, EXPRESS OR IMPLIED, RELATED TO PRODUCTS DESIGNED AND MANUFACTURED BY MANUFACTURERS OTHER THAN HIGH FORMAT®. ALL NATURAL STONE PRODUCTS SOLD BY HIGH FORMAT® ARE SOLD "AS-IS".

All warranty claims must be made prior to the removal or disposal of the defective product. Warranty claims will be reviewed by a company representative and may require samples of defective product for analysis. Warranty does not include removal, installation, or transportation to replace the material. Warranty is not transferable and is extended to the original end user only. Proof of purchase is required.

For additional questions please contact us at (877) 777-6558

GENERAL INFORMATION

COLOR

We at HIGH FORMAT®, along with our media partners, do our best to produce print and digital materials that accurately reflect the true shades and tones of our product. However, we cannot guarantee perfect color matching for project photos, color swatches, or other picture representations. Final color selection should be made from actual material which can be viewed at your local dealer location.

Integral pigments are incorporated into the raw materials for all HIGH FORMAT® products to intentionally produce subtle shades and color variations throughout each block or paver. Therefore no product seen in a photograph will be precisely duplicated. For the most natural appearance, install products from multiple pallets simultaneously. This will create a blended, natural look.

EFFLORESCENCE

Efflorescence is a naturally occurring, chalky, white residue commonly found on concrete surfaces. The presence of efflorescence in no way degrades the integrity of any product. It can usually be removed with efflorescence cleaners and often washes away over time. HIGH FORMAT® does not cover the presence of efflorescence under warranty.

PACKAGING

Variation in color can occur where packaging comes into contact with the product. Often, these variations will fade with time. This does not affect the integrity of the material, and it is not considered to be a defect. Color variation caused by contact with packaging materials is not covered under warranty.

POLYMERIC HAZE

Improper installation of ancillary polymeric sand products may result in the presence of polymeric haze. This discoloration can potentially mute the vibrant colors of concrete products. Hazing is not indicative of the quality of the HIGH FORMAT® product, and should not be considered a source of concern for the product's durability. Because HIGH FORMAT® cannot regulate selection or installation of aftermarket accessory materials, we do not warranty against the presence of polymeric haze. In general, polymeric haze can be cleaned and washes away over time.

HEAVY EQUIPMENT

The broad surface dimensions of HIGH FORMAT®'s slab products are not engineered for vehicular traffic and compaction equipment. The exceptions to this exclusion is the more traditionally dimensioned New Mission pavers. New Mission can be used as driveway pavers and/or finish-compacted. If a compactor is used to aid in installation of New Mission pavers, then a urethane pad should be used with the compactor to protect the detailed surfaces of the pavers from damage.

NORMAL MAINTENANCE AND CARE

As with any product that is continually exposed to the natural environment, cleaning and care may be desired over time to maintain the appearance of your hardscapes. Generous rinsing with water and light scrubbing with a stiff, plastic bristle brush is generally the best way to remove dirt that has accumulated over time. Cleaners and mild detergent designed to be used on concrete products may be used as well. Always follow all manufacturer instructions and test on a small area when using any cleaner. Power washers may cause damage at close range.

WINTER CARE

All metal snow shovels and snow blower blades have the potential to damage concrete surfaces. All snowplows, snow blowers and shovels used to clear HIGH FORMAT® products of snow should use plastic blades or guards. De-icing salts will damage concrete and should not be used with HIGH FORMAT® products unless they are made with TEKTRAMAT® technology. HIGH FORMAT® does not cover damage done by snow removal, de-icing, or improper loading under warranty.

NATURAL STONE

Natural stone is a product of nature. Surface texture and color will vary piece to piece and crate to crate. Our partnering quarries work hard to ship consistent, high quality product, but you should expect variation. Samples are suggested, but will not guarantee color. We highly recommend all material be delivered prior to installation and that available material is blended throughout your project. Each installation will be uniquely different and perfectly created in nature!



HIGHFORMAT.COM

(877) 777-6558

05481 US 31 SOUTH, CHARLEVOIX, MI 49720